

Mobile Phone user manual

- Some contents in this manual may differ from your phone depending on the software of the phone or your service provider.
- Visit the Samsung website to view the Samsung Mobile function guide in Adobe Acrobat (.pdf) format. The function guide contains common topics about applications and features that appear in many different models of Samsung mobile phones.
- Bluetooth QD ID : B016358

www.samsungmobile.com

Printed in Korea
Code No.:GH68-27411A
English (SEA), 03/2010, Rev. 1.1



Safety warnings

Keep your phone away from small children and pets

Keep your phone and all accessories out of reach from small children and pets. Small parts may cause choking or serious injury if swallowed.

Protect your hearing



Excessive exposure to sound at high volumes can cause hearing damage. Always turn the volume down before plugging the earphones into an audio source and use only the minimum volume setting necessary to hear your conversation or music.

Install mobile phones and equipment with caution

Ensure that any mobile phones or related equipment installed in your vehicle are securely mounted. Avoid placing your phone and accessories near or in an air bag deployment area. Improperly installed wireless equipment can cause serious injury when air bags inflate rapidly.

Handle and dispose of batteries and chargers with care

- Use only Samsung-approved batteries and chargers specifically designed for your phone. Incompatible batteries and chargers can cause serious injuries or damage to your phone.
- Never dispose of batteries or phones in a fire. Follow all local regulations when disposing of used batteries or phones.
- Never place batteries or phones on or in heating devices, such as microwave ovens, stoves, or radiators. Batteries may explode when overheated.
- Never crush or puncture the battery. Avoid exposing the battery to high external pressure, which can lead to an internal short circuit and overheating.

Avoid interference with pacemakers

Maintain a minimum of 15 cm (6 inches) between mobile phones and pacemakers to avoid potential interference, as recommended by manufacturers and the independent research group, Wireless Technology Research. If you have any reason to suspect that your phone is interfering with a pacemaker or other medical device, turn off the phone immediately and contact the manufacturer of the pacemaker or medical device for guidance.

Turn off the phone in potentially explosive environments

Do not use your phone at refueling points (service stations) or near fuels or chemicals. Turn off your phone whenever directed by warning signs or instructions. Your phone could cause explosions or fire in and around fuel or chemical storage, transfer areas and blasting areas. Do not store or carry flammable liquids, gases, or explosive materials in the same compartment as the phone, its parts, or accessories.

Reduce the risk of repetitive motion injuries

While using your phone, hold the phone with a relaxed grip, press the keys lightly, use special features that reduce the number of keys you have to press (such as templates and predictive text), and take frequent breaks.

Do not use the phone if the screen is cracked or broken

Broken glass or acrylic could cause injury to your hand and face. Bring the phone to a Samsung service center to replace the screen. Damage caused by careless handling will void your manufacturer's warranty.

CE0168

Turn off the phone or disable the wireless functions when in an aircraft

Your phone can cause interference with aircraft equipment. Follow all airline regulations and turn off your phone or switch to a mode that disables the wireless functions when directed by airline personnel.

Protect batteries and chargers from damage

- Avoid exposing batteries to very cold or very hot temperatures (below 0° C/32° F or above 45° C/113° F). Extreme temperatures can reduce the charging capacity and life of your batteries.
- Prevent batteries from contacting metal objects, as this can create a connection between the + and – terminals of your batteries and lead to temporary or permanent battery damage.
- Never use a damaged charger or battery.

Handle your phone carefully and sensibly

- Disassembling your phone may cause an electric shock.
- Do not allow your phone to get wet—liquids can cause serious damage and will change the color of the label that indicates water damage inside the phone. Do not handle your phone with wet hands. Water damage to your phone can void your manufacturer's warranty.

- Avoid using or storing your phone in dusty, dirty areas to prevent damage to moving parts.
- Your phone is a complex electronic device—protect it from impacts and rough handling to avoid serious damage.
- Do not paint your phone, as paint can clog moving parts and prevent proper operation.
- If your phone has a camera flash or light, avoid using it close to the eyes of children or animals.
- Your phone may be damaged by exposure to magnetic fields. Do not use carrying cases or accessories with magnetic closures or allow your phone to come in contact with magnetic fields for extended periods of time.

Avoid interference with other electronic devices

Your phone emits radio frequency (RF) signals that may interfere with unshielded or improperly shielded electronic equipment, such as pacemakers, hearing aids, medical devices, and other electronic devices in homes or vehicles. Consult the manufacturers of your electronic devices to solve any interference problems you experience.



Important usage information

Use your phone in the normal position

Avoid contact with your phone's internal antenna.

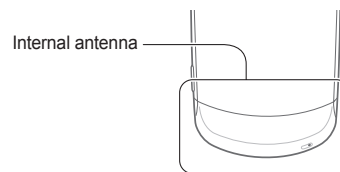

Allow only qualified personnel to service your phone

Allowing non-qualified personnel to service your phone may result in damage to your phone and will void your warranty.

Ensure maximum battery and charger life

- Avoid charging batteries for more than a week, as overcharging may shorten battery life.
- Over time, unused batteries will discharge and must be recharged before use.
- Disconnect chargers from power sources when not in use.
- Use batteries only for their intended purpose.

Handle SIM cards or memory cards with care

- Do not remove a card while the phone is transferring or accessing information, as this could result in loss of data and/or damage to the card or phone.
- Protect cards from strong shocks, static electricity, and electrical noise from other devices.
- Do not touch gold-colored contacts or terminals with your fingers or metal objects. If dirty, wipe the card with a soft cloth.

Ensure access to emergency services

Emergency calls from your phone may not be possible in some areas or circumstances. Before traveling in remote areas without signal coverage, plan an alternate method of contacting emergency services personnel.



Safety precautions

Drive safely at all times

Avoid using your phone while driving and obey all regulations that restrict the use of mobile phones while driving. Use hands-free accessories to increase your safety when possible.

Follow all safety warnings and regulations

Comply with any regulations that restrict the use of a mobile phone in a certain area.

Use only Samsung-approved accessories

Using incompatible accessories may damage your phone or cause injury. In case of headsets, mono headsets are not available. Use stereo headsets only.

Turn off the phone near medical equipment

Your phone can interfere with medical equipment in hospitals or health care facilities. Follow all regulations, posted warnings, and directions from medical personnel.

Specific Absorption Rate (SAR) certification information

Your phone conforms to European Union (EU) standards that limit human exposure to radio frequency (RF) energy emitted by radio and telecommunications equipment. These standards prevent the sale of mobile phones that exceed a maximum exposure level (known as the Specific Absorption Rate, or SAR) of 2.0 W/kg. During testing, the maximum SAR recorded for this model was 0.568 W/kg. In normal use, the actual SAR is likely to be much lower, as the phone has been designed to emit only the RF energy necessary to transmit a signal to the nearest base station. By automatically emitting lower levels when possible, your phone reduces your overall exposure to RF energy. For more information about the SAR and related EU standards, visit the Samsung mobile phone website.

Correct disposal of this product

(Waste Electrical & Electronic Equipment)



(Applicable in the European Union and other European countries with separate collection systems)

This marking on the product, accessories or literature indicates that the product and its electronic accessories (e.g. charger, headset, USB cable) should not be disposed of with other household waste at the end of their working life.

To prevent possible harm to the environment or human health from uncontrolled waste disposal, please separate these items from other types of waste and recycle them responsibly to promote the sustainable reuse of material resources.

Household users should contact either the retailer where they purchased this product, or their local government office, for details of where and how they can take these items for environmentally safe recycling. Business users should contact their supplier and check the terms and conditions of the purchase contract. This product and its electronic accessories should not be mixed with other commercial wastes for disposal.

Correct disposal of batteries in this product



(Applicable in the European Union and other European countries with separate battery return systems)

This marking on the battery, manual or packaging indicates that the batteries in this product should not be disposed of with other household waste at the end of their working life. Where marked, the chemical symbols Hg, Cd or Pb indicate that the battery contains mercury, cadmium or lead above the reference levels in EC Directive 2006/66. If batteries are not properly disposed of, these substances can cause harm to human health or the environment.

To protect natural resources and to promote material reuse, please separate batteries from other types of waste and recycle them through your local, free battery return system.

Phone layout

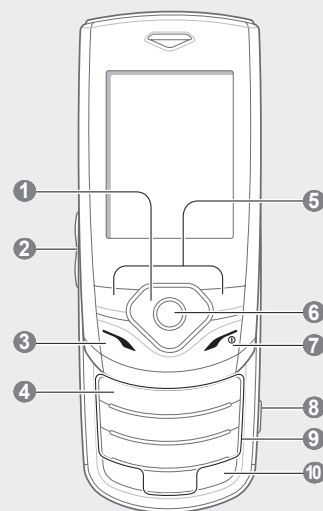

1

4-way navigation key

Scroll through menu options; In Idle mode, access user-defined menus
Depending on your service provider, the default home screen or pre-defined menus may differ

2

Volume key

In Idle mode, adjust the key tone volume; Send an SOS message
See "Activate and send an SOS message"

3

Dial key

Make or answer a call; In Idle mode, retrieve recently dialed, missed, or received numbers

4

Voice mail service key

In Idle mode, access voice mails (press and hold)

5

Softkeys

Perform actions indicated at the bottom of the display

6

Confirm key

Select the highlighted menu option or confirm an input; In Idle mode, launch the web browser or access Menu mode
Depending on your service provider or region, the key may perform differently

7

Power/Menu exit key

Turn the phone on and off (press and hold); End a call; In Menu mode, cancel input and return to Idle mode

8

Camera key

In Idle mode, turn on the camera (press and hold); In Camera mode, take a photo or record a video

9

Alphanumeric keys

10

Silent profile key

In Idle mode, activate or deactivate the silent profile (press and hold)

Your phone displays the following status indicators on the top of the screen:

Icon	Description	Icon	Description
	Signal strength		New multimedia message (MMS)
	GPRS network connected		New voice mail message
	EDGE network connected		New email message
	Call in progress		FM radio on
	Call diverting activated		FM radio suspended
	SOS message feature activated		Music playback in progress
	Alarm activated		Music playback paused
	Connecting to secured web page		Memory card inserted
	Roaming (outside of normal service area)		Normal profile activated
	Bluetooth activated		Silent profile activated
	Synchronized with PC		Battery power level
	New text message (SMS)		Current time

Install the SIM card and battery

- Remove the back cover and battery, and then insert the SIM card.

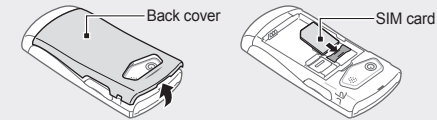

- Insert the battery and replace the back cover.

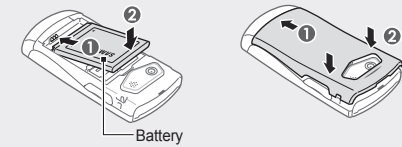

Charge the battery

- Plug the supplied travel adapter.
- When charging is finished, unplug the travel adapter.

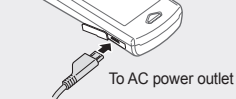

- Do not remove the battery while the phone is connected to the travel charger. Otherwise, the phone may be damaged.

Change your ringtone

- In Menu mode, select **Settings** → **Sound profiles**.
- Scroll to the profile you are using.

- If you are using the silent or offline profile, you are not allowed to change the ringtone.

- Press **<Edit>** → **Voice call ringtone**.
- Select a memory location → a ringtone.

To switch to another profile, select it from the list.

Call a recently dialed number

- In Idle mode, press [↵].
- Scroll left or right to a call type.
- Scroll up or down to a number or name.
- Press the Confirm key to view details of the call or [↵] to dial the number.

Use the smart home screen

The smart home screen allows you to access your favorite applications and contacts and view upcoming events or tasks. You can customize the smart home screen to fit your preferences and needs.

- When you are using the smart home screen, the Navigation key does not work as shortcuts.

Activate the mobile tracker

When someone inserts a new SIM card in your phone, the mobile tracker feature will automatically send the contact number to two recipients to help you locate and recover your phone. To activate the mobile tracker,

- In Menu mode, select **Settings** → **Security** → **Mobile tracker**.
- Enter your password and press **<OK>**.
- The first time you access **Mobile tracker**, you will be prompted to create and confirm a password.
- Press the Confirm key to turn on the mobile tracker feature.
- Scroll down and press the Confirm key to open the recipient list.
- Press **<Options>** → **Phonebook** to open your contact list.
- Select a contact.
- Select a number (if necessary).
- When you are finished selecting contacts, press **<Select>**.
- When you are finished selecting contacts, press **<Select>**.
- Press the Confirm key to save the recipients.
- Scroll down and enter the sender's name.
- Press **<Save>** → **<Accept>**.

Insert a memory card (optional)

Your phone accepts microSD™ or microSDHC™ memory cards up to 8 GB (depending on memory card manufacturer and type).

- Formatting the memory card on a PC may cause incompatibility with your phone. Format the memory card only on the phone.
- Frequent writing and erasing will shorten the life span of memory cards.

- Remove the back cover and battery.
- Unlock the memory card cover.

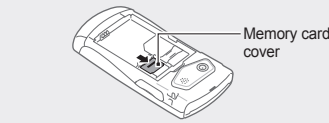

- Lift the memory card cover and insert a memory card with the label side facing up.

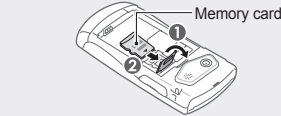

- Close and lock the memory card cover.
- Replace the battery and back cover.

Instructional icons

	Note: notes, usage tips, or additional information
	Followed by: the order of options or menu you must select to perform a step; for example: In Menu mode, select Messages → Create message (represents Messages , followed by Create message)
	Square brackets: phone keys; for example: [↵] (represents the Power/Menu exit key)
	Angled brackets: softkeys that control different functions at each screen; for example: <OK> (represents the OK softkey)

Turn your phone on or off

To turn your phone on,

- Press and hold [↵].
- Enter your PIN and press **<OK>** (if necessary).
- When the setup wizard opens, customize your phone as desired by following the screen.

To turn your phone off, repeat step 1 above.

Customize the smart home screen

- In Menu mode, select **Settings** → **Display** → **Smart home**.
- Press **<Edit>**.
- Select the items to display on the smart home screen.
- Press **<Options>** → **<Save>**.
- Press the Confirm key.

- You can change the idle screen to another style. In Menu mode, select **Settings** → **Display** → **Smart home** and scroll left or right to a style you want.

Access the smart home idle items

Press the Navigation key to scroll through the items on the smart home screen and press the Confirm key to select an item. The following items are available.

- Available items may vary depending on your service provider.

- Shortcuts toolbar:** access your favorite applications. You can customize the shortcut toolbar as desired.
- My buddies:** access contacts that are saved in the favorite number list.
- PIMs ticker:** access upcoming calendar events and tasks.
- Monthly calendar:** view the monthly calendar.
- Single clock:** view the current time and date.
- Dual clock:** view your home clock and a world clock.

Activate and send an SOS message

In an emergency, you can send SOS messages to your family or friends for help.

To activate the SOS message

- In Menu mode, select **Messages** → **Settings** → **SOS messages** → **Sending options**.
- Press the Confirm key to turn on the SOS message.
- Scroll down and press the Confirm key to open the recipient list.
- Press **<Options>** → **Search** to open your contact list.
- Select a contact.
- Select a number (if necessary).
- When you are finished selecting contacts, press the Confirm key to save the recipients.
- Scroll down and set the number of times to repeat the SOS message.
- Press **<Back>** → **<Yes>**.

To send an SOS message

- With the phone closed and the keys locked, press [▲/▼] four times to send an SOS message to preset numbers. The phone switches to SOS mode and sends the preset SOS message.
- To exit SOS mode, press [↵].

Customize the shortcut toolbar

- In Menu mode, select **Settings** → **Display** → **Smart home**.
- Press **<Edit>**.
- Scroll to **Shortcuts toolbar** and press **<Options>** → **Edit shortcuts**.
- Scroll to a menu to change or an empty location and press **<Edit>**.
- Select the menus you want. Press **<Options>** → **Open** to select submenus (if necessary).
- Press **<Save>**, or press **<Options>** → **Save**.

Enter text

To change the text input mode

- Press and hold [#] to switch between T9 and ABC modes. Depending on your region, you may be able to access an input mode for your specific language.
- Press [#] to change case or switch to Number mode.
- Press [*] to switch to Symbol mode.
- Press and hold [*] to access writing options.

T9 mode

- Press appropriate alphanumeric keys to enter an entire word.
- When the word displays correctly, press [0] to insert a space. If the correct word does not display, select an alternate word from the list that appears.

Use the camera

To capture photos

- In Idle mode, press and hold [📷] to turn on the camera.
- Rotate the phone counterclockwise to landscape view.
- Aim the lens at the subject and make any adjustments.
- Press the Confirm key or [📷] to take a photo. The photo is saved automatically.

To view photos

In Menu mode, select **My files** → **Images** → a photo file.

To capture videos

- In Idle mode, press and hold [📷] to turn on the camera.
- Rotate the phone counterclockwise to landscape view.
- Press [1] to switch to Recording mode.
- Aim the lens at the subject and make any adjustments.
- Press the Confirm key or [📷] to start recording.
- Press <▣> or [📷] to stop recording. The video is saved automatically.

To view videos

In Menu mode, select **My files** → **Videos** → a video file.

Access menus

To access your phone's menus,

- In Idle mode, press **<Menu>** or the Confirm key to access Menu mode.

- You may need to press the Confirm key to access Menu mode depending on your region or service provider. When you are using the smart home screen, you cannot use the Confirm key to access Menu mode.

- Use the Navigation key to scroll to a menu or option.
- Press **<Select>**, **<OK>**, or the Confirm key to confirm the highlighted option.
- Press **<Back>** to move up one level; Press [↵] to return to Idle mode.

- When you access a menu requiring the PIN2, you must enter the PIN2 supplied with the SIM card. For details, contact your service provider.
- Samsung is not responsible for any loss of passwords or private information or other damages caused by illegal software.

Make a call

- In Idle mode, enter an area code and a phone number.
- Press [↵] to dial the number.
- To end the call, press [↵].

Answer a call

- When a call comes in, press [↵].
- To end the call, press [↵].

Adjust the volume

To adjust the volume of the ringtone

- In Menu mode, select **Settings** → **Sound profiles**.
- Scroll to the profile you are using.

- If you are using the silent or offline profile, you are not allowed to adjust the volume of the ringtone.

- Press **<Edit>** → **Volume** → **Call alert**.
- Scroll left or right to adjust the volume level and press **<Save>**.

To adjust the volume of voice during a call

While a call is in progress, press [▲/▼] to adjust the volume.

- In noisy environments, you may have difficulty hearing the calls while using the speakerphone feature. For better audio performance, use the normal phone mode.

Send and view messages

To send a text or multimedia message

- In Menu mode, select **Messages** → **Create message**.
- Enter a recipient number and scroll down.
- Enter your message text. ► *Enter text*
For sending as a text message, skip to step 5. For attaching multimedia, continue with step 4.
- Press **<Options>** → **Add multimedia** and add an item.
- Press the Confirm key to send the message.

To view text or multimedia messages

- In Menu mode, select **Messages** → **Inbox**.
- Select a text or multimedia message.

Make fake calls

You can simulate an incoming call when you want to get out of meetings or unwanted conversations.

- You must set a shortcut key to make a fake call. In Menu mode, select **Settings** → **Phone** → **Shortcuts** and set a shortcut key for **Fake call**. To set and use a shortcut key, you must deactivate the smart home screen.

To make a fake call

- In Idle mode, press and hold the shortcut key.
- With the phone closed and the keys locked, press the shortcut key four times.

Listen to the FM radio

- Plug the supplied headset into the phone.
- In Menu mode, select **Applications** → **FM radio**.
- Press the Confirm key to start the FM radio.
- Press **<Yes>** to start automatic tuning. The radio scans and saves available stations automatically.

- The first time you turn on the FM radio, you will be prompted to start automatic tuning.

- Control the FM radio using the following keys:

Key	Function
Confirm	Turn the FM radio on or off
Navigation	• Left/Right: Select a saved radio station • UP/Down: Select a radio station in the favorite list
Volume	Adjust the volume

- To turn off the FM radio, press the Confirm key.

Key	Function
Confirm	Pause or resume playback
▲/▼	Adjust the volume
Navigation	• Left: Restart playback; Skip backward (press within 2 seconds); Scan backward in a file (press and hold) • Right: Skip forward; Scan forward in a file (press and hold) • Up: Open the playlist • Down: Change the repeat mode