

**NOKIA**

# **Nokia 235 4G**

## **User Guide**

## Table of Contents

|          |   |           |
|----------|---|-----------|
| <b>1</b> | <b>About this user guide</b>                  | <b>4</b>  |
| <b>2</b> | <b>Get started</b>                            | <b>5</b>  |
|          | Keys and parts . . . . .                      | 5         |
|          | Set up and switch on your phone . . . . .     | 6         |
|          | Charge your phone . . . . .                   | 8         |
|          | Keypad . . . . .                              | 9         |
| <b>3</b> | <b>Calls, contacts, and messages</b>          | <b>10</b> |
|          | Calls . . . . .                               | 10        |
|          | Contacts . . . . .                            | 10        |
|          | Send messages . . . . .                       | 11        |
| <b>4</b> | <b>Personalise your phone</b>                 | <b>12</b> |
|          | Change tones . . . . .                        | 12        |
|          | Change the look of your home screen . . . . . | 12        |
|          | Profiles . . . . .                            | 12        |
| <b>5</b> | <b>Camera</b>                                 | <b>13</b> |
|          | Photos and videos . . . . .                   | 13        |
| <b>6</b> | <b>Clock, calendar, and calculator</b>        | <b>14</b> |
|          | Set the time and date manually . . . . .      | 14        |
|          | Alarm clock . . . . .                         | 14        |
|          | Calendar . . . . .                            | 14        |
|          | Calculator . . . . .                          | 14        |
| <b>7</b> | <b>Erase your phone's data</b>                | <b>15</b> |
|          | Restore factory settings . . . . .            | 15        |

|  |           |
|--|-----------|
| <b>8 Product and safety information</b>            | <b>16</b> |
| For your safety . . . . .                          | 16        |
| Emergency calls . . . . .                          | 18        |
| Take care of your device . . . . .                 | 18        |
| Recycle . . . . .                                  | 19        |
| Crossed-out wheellie bin symbol . . . . .          | 20        |
| Battery and charger information . . . . .          | 20        |
| Small children . . . . .                           | 21        |
| Medical devices . . . . .                          | 21        |
| Implanted medical devices . . . . .                | 22        |
| Hearing . . . . .                                  | 22        |
| Protect your device from harmful content . . . . . | 22        |
| Vehicles . . . . .                                 | 23        |
| Potentially explosive environments . . . . .       | 23        |
| Certification information . . . . .                | 23        |
| About Digital Rights Management . . . . .          | 24        |
| Copyrights and other notices . . . . .             | 24        |

# 1 About this user guide



**Important:** For important information on the safe use of your device and battery, read "Product and safety information" before you take the device into use. To find out how to get started with your new device, read the user guide.

## 2 Get started

### KEYS AND PARTS

#### Your phone

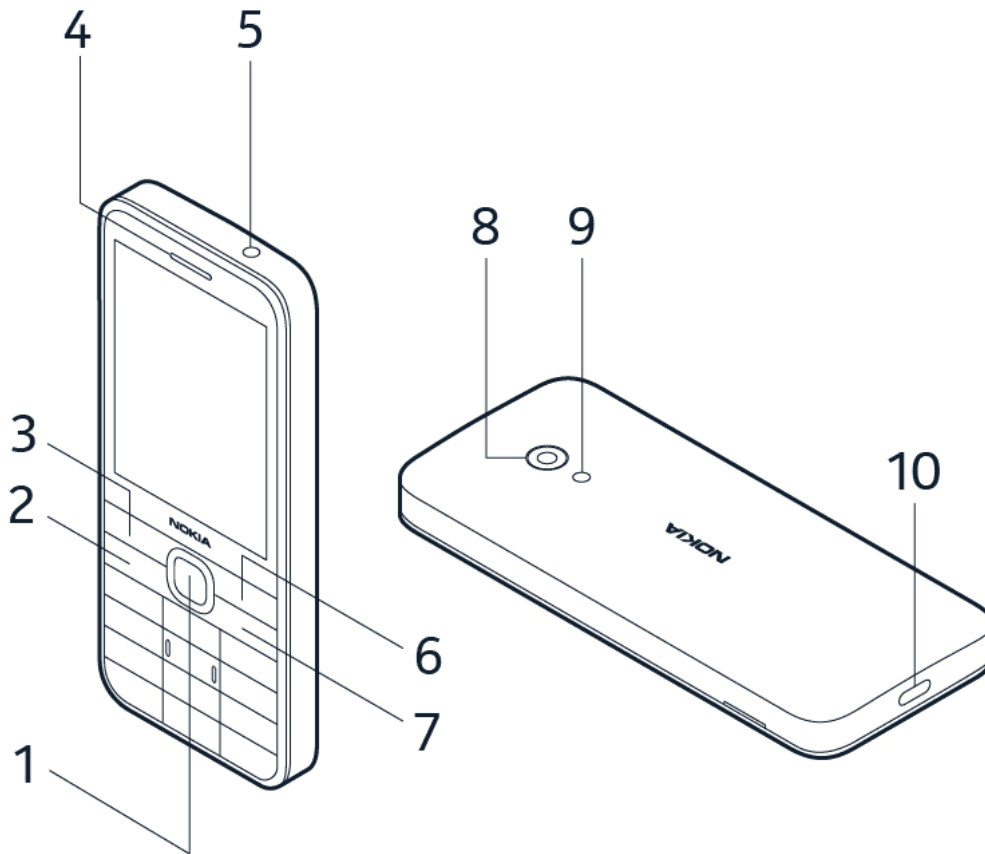

This user guide applies to the following models: TA-1559, TA-1543, TA-1549, TA-1556, TA-1563, TA-1545.

- |                         |                               |
|-------------------------|-------------------------------|
| 1. Microphone           | 7. Headset connector          |
| 2. Call key             | 8. Right selection key        |
| 3. Left selection key   | 9. Power/End key              |
| 4. Scroll key           | 10. Camera                    |
| 5. Earpiece/Loudspeaker | 11. Charging cradle connector |
| 6. Torch                | 12. USB connector             |

Some of the accessories mentioned in this user guide, such as chargers, headsets, or data cables, may be sold separately.



Note: You can set the phone to ask for a security code to protect your privacy and personal data. The pre-set code is 12345. To change the code, select **Menu** > **Settings** > **Security** > **Phone locked**, create a code with 4-8 digits, and select **OK**. Note, however, that you need to remember the code, as HMD Global is not able to open or bypass it.

## Parts and connectors, magnetism

Do not connect to products that create an output signal, as this may damage the device. Do not connect any voltage source to the audio connector. If you connect an external device or headset, other than those approved for use with this device, to the audio connector, pay special attention to the volume levels.

Parts of the device are magnetic. Metallic materials may be attracted to the device. Do not place credit cards or other magnetic stripe cards near the device for extended periods of time, since the cards may be damaged.

## SET UP AND SWITCH ON YOUR PHONE



**Note:** Pre-installed system software and apps use a significant part of memory space.

## Nano-SIM



**Important:** This device is designed to be used with a nano-SIM card only. Use of incompatible SIM cards may damage the card or the device, and may corrupt data stored on the card.



**Note:** Switch the device off and disconnect the charger and any other device before removing any covers. Avoid touching electronic components while changing any covers. Always store and use the device with any covers attached.

## Open the back cover

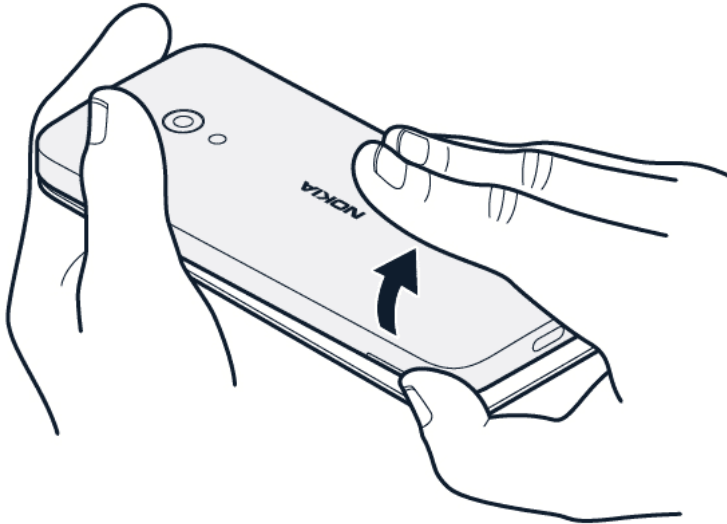

1. Place your fingernail in the small slot at the bottom of the phone, then lift and remove the cover.
2. If the battery is in the phone, take it out.

## Insert the SIM cards

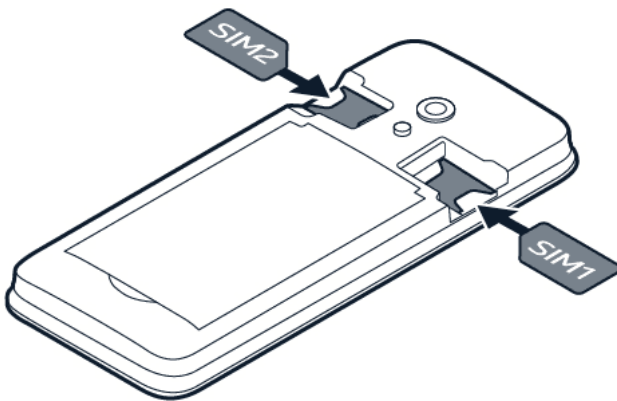

1. Slide the SIM card in the SIM card slot.
2. If you have a dual-SIM phone, slide the second SIM in the SIM2 slot.

Both SIM cards are available at the same time when the device is not being used, but while one SIM card is active, for example, when making a call, the other may be unavailable.



**Tip:** To find out if your phone can use 2 SIM cards, see the label on the sales box. If there are 2 IMEI codes on the label, you have a dual-SIM phone.

## Insert the memory card

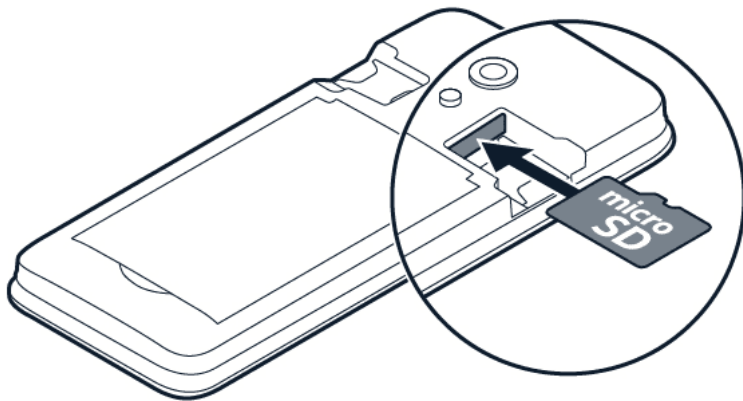

1. Slide the memory card in the memory card slot.
2. Put back the battery.
3. Put back the back cover.

Use only compatible memory cards approved for use with this device. Incompatible cards may damage the card and the device and corrupt data stored on the card.



**Tip:** Use a fast microSD memory card (up to 32 GB) from a well-known manufacturer.

## Switch on your phone

Press and hold .

## CHARGE YOUR PHONE

Your battery has been partially charged at the factory, but you may need to recharge it before you can use your phone.

### Charge the battery

1. Plug the charger into a wall outlet.
2. Connect the charger to the phone. When done, unplug the charger from the phone and then from the wall outlet.



If the battery is completely discharged, it may take several minutes before the charging indicator is displayed.





**Tip:** You can use USB charging when a wall outlet is not available. The efficiency of USB charging power varies significantly and it may take a long time for charging to start and the device to start functioning.

## KEYPAD

### Use the phone keys

- To see your phone's apps and features, select **Menu** on the home screen.
- To go to an app or feature, press the scroll key up, down, left, or right. To open an app or feature, press the scroll key.
- If you have selected the zoomed menu view, press the scroll key up or down to go to an app or feature. To open an app or feature, press the scroll key.

### Lock the keypad

To avoid accidentally pressing the keys, lock the keypad: select  > **Lock keypad**. To unlock the keypad, press , and select **Unlock** > .

### Type with the keypad

Press a key repeatedly until the letter is shown.

To enter a space press **0**.

To type a special character or punctuation mark, select  > **Insert options** > **Insert symbol**.

To switch between character cases, press **#** repeatedly.

To type a number, press and hold a number key.

## 3 Calls, contacts, and messages

### CALLS

#### Make a call

Learn how to make a call with your new phone.

1. Type in the phone number. To type in the + character, used for international calls, press \* twice.
2. Press the call key. If asked, select which SIM to use.
3. To end the call, press the end key.

#### Answer a call



Press .

### CONTACTS

#### Add a contact

1. Select **Menu** > **Contacts** >  > **Add new contact**.
2. Select where to save the contact.
3. Enter the name and the number.
4. Choose **Save**.

#### Save a contact from the call logs

1. Select **Menu** > **Call logs**, and select the call type.
2. Scroll to the number you want to save, select  > **Add to contacts**, and select **Add to new contact** to create a new contact, or **Add to existing contact** to add the number to a contact in your contacts list.
3. Select where to save the contact.
4. Add the contact details and select .

## Call a contact

You can call a contact directly from the contact list.

Select **Menu** > **Contacts**, scroll to the contact you want to call, and press the call key.

## SEND MESSAGES

### Write and send messages

1. Select **Menu** > **Messages** > **Create message**.
2. Write your message.
3. To insert numbers or symbols to the message, select **≡** > **Insert options** > **Insert number** or **Insert symbol**.
4. Select **≡** > **Send**. If asked, select which SIM to use.
5. Type in a phone number, or select **Search** and a recipient from your contacts list.
6. Select **OK**.

## 4 Personalise your phone

### CHANGE TONES

#### Set new tones

1. Select **Menu** > **⚙️** > **Tone settings**.
2. Select which tone you want to change and select which SIM card you want to change it for, if asked.
3. Scroll to the tone that you want and select **OK**.

### CHANGE THE LOOK OF YOUR HOME SCREEN

#### Choose a new wallpaper

You can change the background of your home screen.

1. Select **Menu** > **Settings** > **Personalisation** > **Lock screen background** > **Wallpapers**.
2. Select the wallpaper you want.

### PROFILES

#### Set a profile

There are several profiles that you can use in different situations. There is, for example, a silent profile for when you cannot have sounds on and an outdoor profile with loud tones.

1. Select **Menu** > **Settings** > **Profiles**.
2. To adjust a profile, scroll to it, and select **≡** > **Settings**. Change the settings you want.
3. To set on a profile, scroll to it, and select **Select**.

## 5 Camera



### PHOTOS AND VIDEOS

#### Take a photo

1. Select **Menu** > **Camera**.
2. To zoom in or out, scroll up or down.
3. To take a photo, press the scroll key.

To see the photo you just took, on the home screen, select **Menu** > **Gallery**.

#### Record a video

1. To switch the video camera on, select **Menu** > **Camera** and scroll to .
2. To start recording, press the scroll key.
3. To stop recording, select .

To see the video you just recorded, on the home screen, select **Menu** > **Video**.

## 6 Clock, calendar, and calculator



### SET THE TIME AND DATE MANUALLY

#### Change the time and date

1. Select **Menu** > **Settings** > **Phone settings** > **Time & date**.
2. Select **Update time settings** and switch **Auto update time** off.
3. Select **Manual update time** and enter the time and date.
4. Select ←.

### ALARM CLOCK

#### Set an alarm

1. Select **Menu** > **Alarm**.
2. Select  and enter the alarm time and other details.
3. Select .

### CALENDAR

#### Add a calendar event

1. Select **Menu** > .
2. Scroll to a date, and select **Opt.** > **Add reminder**.
3. Enter the event name, and select **OK**.
4. Select whether to add an alarm to the event, and select **OK**.

### CALCULATOR

#### Use the calculator

1. Select **Menu** > **Calculator**.
2. Enter the first factor of your calculation, use the scroll key to select the operation, and enter the second factor.
3. Press the scroll key to get the result of the calculation.

Select  to empty the number fields.

## 7 Erase your phone's data

### RESTORE FACTORY SETTINGS

#### Reset your phone

You can restore the original factory settings, but be careful, since this reset removes all data you have saved in the phone's memory and all of your personalisation.

If you are disposing your phone, note that you are responsible of removing all private content.

To reset your phone to its original settings and to remove all your data, on the home screen, type in `*#7370#`. If asked, enter your security code.

## 8 Product and safety information

### FOR YOUR SAFETY

Read these simple guidelines. Not following them may be dangerous or against local laws and regulations. For further information, read the complete user guide.

#### SWITCH OFF IN RESTRICTED AREAS



Switch the device off when mobile device use is not allowed or when it may cause interference or danger, for example, in aircraft, in hospitals or near medical equipment, fuel, chemicals or blasting areas. Obey all instructions in restricted areas.

#### ROAD SAFETY COMES FIRST



Obey all local laws. Always keep your hands free to operate the vehicle while driving. Your first consideration while driving should be road safety.

#### INTERFERENCE



All wireless devices may be susceptible to interference, which could affect performance.



## **AUTHORISED SERVICE**



Only authorised personnel may install or repair this product.

## **BATTERIES, CHARGERS, AND OTHER ACCESSORIES**



Use only batteries, chargers, and other accessories approved by HMD Global Oy for use with this device. Do not connect incompatible products.

## **KEEP YOUR DEVICE DRY**



If your device is water-resistant, see its IP rating in the device's technical specifications for more detailed guidance.

## PROTECT YOUR HEARING



To prevent possible hearing damage, do not listen at high volume levels for long periods. Exercise caution when holding your device near your ear while the loudspeaker is in use.

## EMERGENCY CALLS



**Important:** Connections cannot be guaranteed in all conditions. Never rely solely on any wireless phone for essential communications like medical emergencies.

Before making the call:

- Switch the phone on.
  - If the phone screen and keys are locked, unlock them.
  - Move to a place with adequate signal strength.
1. Press the end key repeatedly, until the home screen is shown.
  2. Type in the official emergency number for your present location. Emergency call numbers vary by location.
  3. Press the call key.
  4. Give the necessary information as accurately as possible. Do not end the call until given permission to do so.

You may also need to do the following:

- Put a SIM card in the phone.
- If your phone asks for a PIN code, type in the official emergency number for your present location, and press the call key.
- Switch off the call restrictions on your phone, such as call barring, fixed dialling, or closed user group.

## TAKE CARE OF YOUR DEVICE

Handle your device, battery, charger, and accessories with care. The following suggestions help you keep your device operational.

- Keep the device dry. Precipitation, humidity, and all types of liquids or moisture can contain minerals that corrode electronic circuits.
- Do not use or store the device in dusty or dirty areas.
- Do not store the device at high temperatures. High temperatures may damage the device or battery.
- Do not store the device at cold temperatures. When the device warms to its normal temperature, moisture can form inside the device and damage it.
- Do not open the device other than as instructed in the user guide.
- Unauthorised modifications may damage the device and violate regulations governing radio devices.
- Do not drop, knock, or shake the device or the battery. Rough handling can break it.
- Only use a soft, clean, dry cloth to clean the surface of the device.
- Do not paint the device. Paint can prevent proper operation.
- Keep the device away from magnets or magnetic fields.
- To keep your important data safe, store it in at least two separate places, such as your device, memory card, or computer, or write down important information.

During extended operation, the device may feel warm. In most cases, this is normal. To avoid getting too warm, the device may automatically slow down, close apps, switch off charging, and if necessary, switch itself off. If the device is not working properly, take it to the nearest authorised service facility.

## RECYCLE



Always return your used electronic products, batteries, and packaging materials to dedicated collection points. This way you help prevent uncontrolled waste disposal and promote the recycling of materials. Electrical and electronic products contain a lot of valuable materials, including metals (such as copper, aluminium, steel, and magnesium) and precious metals (such as gold, silver, and palladium). All of the materials in the device can be recovered as materials and energy.

## CROSSED-OUT WHEELIE BIN SYMBOL

### Crossed-out wheelie bin symbol



The crossed-out wheelie-bin symbol on your product, battery, literature or packaging reminds you that all electrical and electronic products and batteries must be taken to separate collection at the end of their working life. Remember to remove personal data from the device first. Do not dispose of these products as unsorted municipal waste: take them for recycling. For info on your nearest recycling point, check with your local waste authority, or read about HMD's take-back program and its availability in your country at [www.hmd.com/phones/support/topics/recycle](http://www.hmd.com/phones/support/topics/recycle).

## BATTERY AND CHARGER INFORMATION

### Battery and charger information

To check if your phone has a removable or non-removable battery, see the printed guide.

**Devices with a removable battery** Only use your device with its original rechargeable battery. The battery can be charged and discharged hundreds of times, but it will eventually wear out. When the talk and standby times are noticeably shorter than normal, replace the battery.

**Devices with a non-removable battery** Do not attempt to remove the battery, as you may damage the device. The battery can be charged and discharged hundreds of times, but it will eventually wear out. When the talk and standby times are noticeably shorter than normal, take the device to the nearest authorised service facility to have the battery replaced.

Charge your device with a compatible charger. Charger plug type may vary. Charging time can vary depending on device capability.

### Battery and charger safety information

Once your device is fully charged, unplug the charger from the device and electrical outlet. Please note that continuous charging should not exceed 12 hours. If left unused, a fully charged battery will lose its charge over time.

Extreme temperatures reduce the capacity and lifetime of the battery. Always keep the battery between 15°C and 25°C (59°F and 77°F) for optimal performance. A device with a

hot or cold battery may not work temporarily. Note that the battery may drain quickly in cold temperatures and lose enough power to switch off the phone within minutes. When you are outdoors in cold temperatures, keep your phone warm.

Obey local regulations. Recycle when possible. Do not dispose as household waste.

Do not expose the battery to extremely low air pressure or extremely high temperature, such as disposing of it in a fire, as that may cause the battery to explode or leak flammable liquid or gas.

Do not dismantle, cut, crush, bend, puncture, or otherwise damage the battery in any way. If a battery leaks, do not let liquid touch skin or eyes. If this happens, immediately flush the affected areas with water or seek medical help. Do not modify, attempt to insert foreign objects into the battery, or immerse or expose it to water or other liquids. Batteries may explode if damaged.

Use the battery and charger for their intended purposes only. Improper use of, or use of unapproved or incompatible, batteries or chargers may present a risk of fire, explosion, or other hazards, and may invalidate any approval or warranty. If you believe the battery or charger is damaged, take it to a service centre or your local phone shop before continuing to use it. Never use a damaged battery or charger. Only use the charger indoors. Do not charge your device during a lightning storm. When charger is not included in the sales pack, charge your device using the data cable (included) and a USB power adaptor (may be sold separately). You can charge your device with third-party cables and power adaptors that are compliant with USB 2.0 or later and with applicable country regulations and international and regional safety standards. Other adaptors may not meet applicable safety standards, and charging with such adaptors could pose a risk of property loss or personal injury.

To unplug a charger or an accessory, hold and pull the plug, not the cord.

Additionally, the following applies if your device has a removable battery:

- Always switch the device off and unplug the charger before removing any covers or the battery.
- Accidental short-circuiting can happen when a metallic object touches the metal strips on the battery. This may damage the battery or the other object.

## **SMALL CHILDREN**

Your device and its accessories are not toys. They may contain small parts. Keep them out of the reach of small children.

## **MEDICAL DEVICES**

Operation of radio transmitting equipment, including wireless phones, may interfere with the function of inadequately shielded medical devices. Consult a physician or the medical device's manufacturer to determine if it is adequately shielded from external radio energy.

## IMPLANTED MEDICAL DEVICES

To avoid potential interference, manufacturers of implanted medical devices (such as cardiac pacemakers, insulin pumps and neurostimulators) recommend a minimum separation of 15.3 centimetres (6 inches) between a wireless device and the medical device. Persons who have such devices should:

- Always keep the wireless device more than 6 inches (15.3 centimetres) from the medical device.
- Not carry the wireless device in a breast pocket.
- Hold the wireless device to the ear opposite the medical device.
- Switch the wireless device off if there is any reason to suspect that interference is taking place.
- Follow the manufacturer's directions for the implanted medical device.

If you have any questions about using your wireless device with an implanted medical device, consult your health care provider.

## HEARING



**Warning:** When you use the headset, your ability to hear outside sounds may be affected. Do not use the headset where it can endanger your safety.

Some wireless devices may interfere with some hearing aids.

## PROTECT YOUR DEVICE FROM HARMFUL CONTENT

Your device may be exposed to viruses and other harmful content. Take the following precautions:

- Be cautious when opening messages. They may contain malicious software or otherwise be harmful to your device or computer.
- Be cautious when accepting connectivity requests or browsing the internet. Do not accept Bluetooth® connections from sources you do not trust.
- Install antivirus and other security software on any connected computer.
- If you access preinstalled bookmarks and links to third-party internet sites, take the appropriate precautions. HMD Global does not endorse or assume liability for such sites.

## VEHICLES

Radio signals may affect improperly installed or inadequately shielded electronic systems in vehicles. For more information, check with the manufacturer of your vehicle or its equipment. Only authorised personnel should install the device in a vehicle. Faulty installation may be dangerous and invalidate your warranty. Check regularly that all wireless device equipment in your vehicle is mounted and operating properly. Do not store or carry flammable or explosive materials in the same compartment as the device, its parts, or accessories. Do not place your device or accessories in the air bag deployment area.

## POTENTIALLY EXPLOSIVE ENVIRONMENTS

Switch your device off in potentially explosive environments, such as near petrol pumps. Sparks may cause an explosion or fire resulting in injury or death. Note restrictions in areas with fuel, chemical plants, or where blasting operations are in progress. Areas with a potentially explosive environment may not be clearly marked. These are usually areas where you are advised to switch your engine off, below deck on boats, chemical transfer or storage facilities, and where the air contains chemicals or particles. Check with the manufacturers of vehicles using liquefied petroleum gas (such as propane or butane) if this device can be safely used in their vicinity.

## CERTIFICATION INFORMATION

**This mobile device meets guidelines for exposure to radio waves.**

Your mobile device is a radio transmitter and receiver. It is designed not to exceed the limits for exposure to radio waves (radio frequency electromagnetic fields), recommended by international guidelines from the independent scientific organisation, ICNIRP. These guidelines incorporate substantial safety margins that are intended to assure the protection of all persons regardless of age and health. The exposure guidelines are based on the Specific Absorption Rate (SAR), which is an expression of the amount of radio frequency (RF) power deposited in the head or body when the device is transmitting. The ICNIRP SAR limit for mobile devices is 2.0 W/kg averaged over 10 grams of tissue.

SAR tests are carried out with the device in standard operating positions, transmitting at its highest certified power level, in all its frequency bands.

This device meets RF exposure guidelines when used against the head or when positioned at least  $\frac{5}{8}$  inches (1.5 centimetres) away from the body. When a carry case, belt clip, or other form of device holder is used for body-worn operation, it should not contain metal and should provide at least the above stated separation distance from the body.

To send data or messages, a good connection to the network is needed. Sending may be delayed until such a connection is available. Follow the separation distance instructions until the sending is finished.

During general use, the SAR values are usually well below the values stated above. This is because, for purposes of system efficiency and to minimise interference on the network,

the operating power of your mobile device is automatically decreased when full power is not needed for the call. The lower the power output, the lower the SAR value.

Device models may have different versions and more than one value. Component and design changes may occur over time and some changes could affect SAR values.

For more information, go to [www.sar-tick.com](http://www.sar-tick.com). Note that mobile devices may be transmitting even if you are not making a voice call.

The World Health Organisation (WHO) has stated that current scientific information does not indicate the need for any special precautions when using mobile devices. If you are interested in reducing your exposure, they recommend you limit your usage or use a hands-free kit to keep the device away from your head and body. For more information and explanations and discussions on RF exposure, go to the WHO website at [www.who.int/health-topics/electromagnetic-fields#tab=tab\\_1](http://www.who.int/health-topics/electromagnetic-fields#tab=tab_1).

Please refer to [www.hmd.com/sar](http://www.hmd.com/sar) for the maximum SAR value of the device.

## **ABOUT DIGITAL RIGHTS MANAGEMENT**

When using this device, obey all laws and respect the local customs, privacy, and legitimate rights of others, including copyrights. Copyright protection may prevent you from copying, modifying, or transferring photos, music, and other content.

## **COPYRIGHTS AND OTHER NOTICES**

### **Copyright**

The availability of products, features, apps, and services may vary by region. For more information, contact your dealer or your service provider. This device may contain commodities, technology, or software subject to export laws and regulations from the US and other countries. Diversion contrary to law is prohibited.

The contents of this document are provided "as is". Except as required by applicable law, no warranties of any kind, either express or implied, including, but not limited to, the implied warranties of merchantability and fitness for a particular purpose, are made in relation to the accuracy, reliability, or contents of this document. HMD Global reserves the right to revise this document or withdraw it at any time without prior notice.

To the maximum extent permitted by applicable law, under no circumstances shall HMD Global or any of its licensors be responsible for any loss of data or income or any special, incidental, consequential, or indirect damages howsoever caused.

Reproduction, transfer, or distribution of part or all of the contents in this document in any form without the prior written permission of HMD Global is prohibited. HMD Global operates a policy of continuous development. HMD Global reserves the right to make changes and improvements to any of the products described in this document without prior notice.



HMD Global does not make any representations, provide a warranty, or take any responsibility for the functionality, content, or end-user support of third-party apps provided with your device. By using an app, you acknowledge that the app is provided as is.

Downloading of maps, games, music, and videos and uploading of images and videos may involve transferring large amounts of data. Your service provider may charge for the data transmission. The availability of particular products, services, and features may vary by region. Please check with your local dealer for further details and availability of language options.

Certain features, functions, and product specifications may be network dependent and subject to additional terms, conditions, and charges.

All information about specifications, features, and products is subject to change without notice.

The HMD Global Privacy Policy, available at <http://www.hmd.com/privacy>, applies to your use of the device.

HMD Global Oy is the exclusive licensee of the Nokia brand for phones & tablets. Nokia is a registered trademark of Nokia Corporation.

This product includes open source software. For applicable copyright and other notices, permissions, and acknowledgements, select `*#6774#` on the home screen.