

# TCL 303



5131E

## Note:

This is a user manual for TCL 303 (5131E).

There may be certain differences between the user manual description and the phone's operation, depending on the software release of your phone or specific carrier services.

## Help

Refer to the following resources to get more FAQ, software, and service information:

### Consulting FAQ

Go to <https://support.tcl.com/ca>

### Finding your serial number or IMEI

You can find your serial number or International Mobile Equipment Identity (IMEI) on the packaging materials. Alternatively, choose **Settings > System > About phone > Status > IMEI information** on the phone itself.

### Obtaining warranty service

For information on warranty of your device, visit the Canada website at <https://www.tcl.com/ca/en/mobile/warranty>

### Viewing legal information

On the phone, go to **Settings > System > About phone > Legal information**.

# Table of Contents

<b>1</b>	<b>Basics .....</b>	<b>4</b>
1.1	Device overview .....	4
1.2	Getting started.....	7
1.3	Home screen.....	9
1.4	Text input.....	16
<b>2</b>	<b>Multimedia applications.....</b>	<b>18</b>
2.1	Camera.....	18
2.2	Gallery.....	21
2.3	Music.....	24
<b>3</b>	<b>Apps and features .....</b>	<b>25</b>
3.1	Phone.....	25
3.2	Contacts .....	30
3.3	Messages.....	34
3.4	Calendar.....	36
3.5	Clock .....	37
3.6	Calculator .....	39
3.7	TCL apps.....	39
3.8	Other applications .....	39
3.9	Google applications.....	40
<b>4</b>	<b>Settings.....</b>	<b>42</b>
4.1	Wi-Fi.....	42
4.2	Bluetooth .....	43
4.3	SIM card & cellular network .....	44
4.4	Connected devices.....	46

4.5	Home screen & lock screen.....	47
4.6	Display.....	48
4.7	Sound & vibration.....	49
4.8	Notifications.....	50
4.9	Button & gestures .....	50
4.10	Smart Manager .....	50
4.11	Security & biometrics .....	51
4.12	Location.....	51
4.13	Privacy.....	51
4.14	Apps.....	52
4.15	Storage.....	52
4.16	Accounts.....	52
4.17	Digital Wellbeing & parental controls .....	52
4.18	Google.....	52
4.19	Accessibility.....	53
4.20	System .....	53
<b>5</b>	<b>FOTA upgrade .....</b>	<b>55</b>
<b>6</b>	<b>Troubleshooting.....</b>	<b>56</b>
<b>7</b>	<b>Specifications .....</b>	<b>62</b>
<b>8</b>	<b>Accessories.....</b>	<b>64</b>
<b>9</b>	<b>Licenses .....</b>	<b>65</b>
<b>10</b>	<b>Disclaimer.....</b>	<b>66</b>

# 1 Basics

## 1.1 Device overview

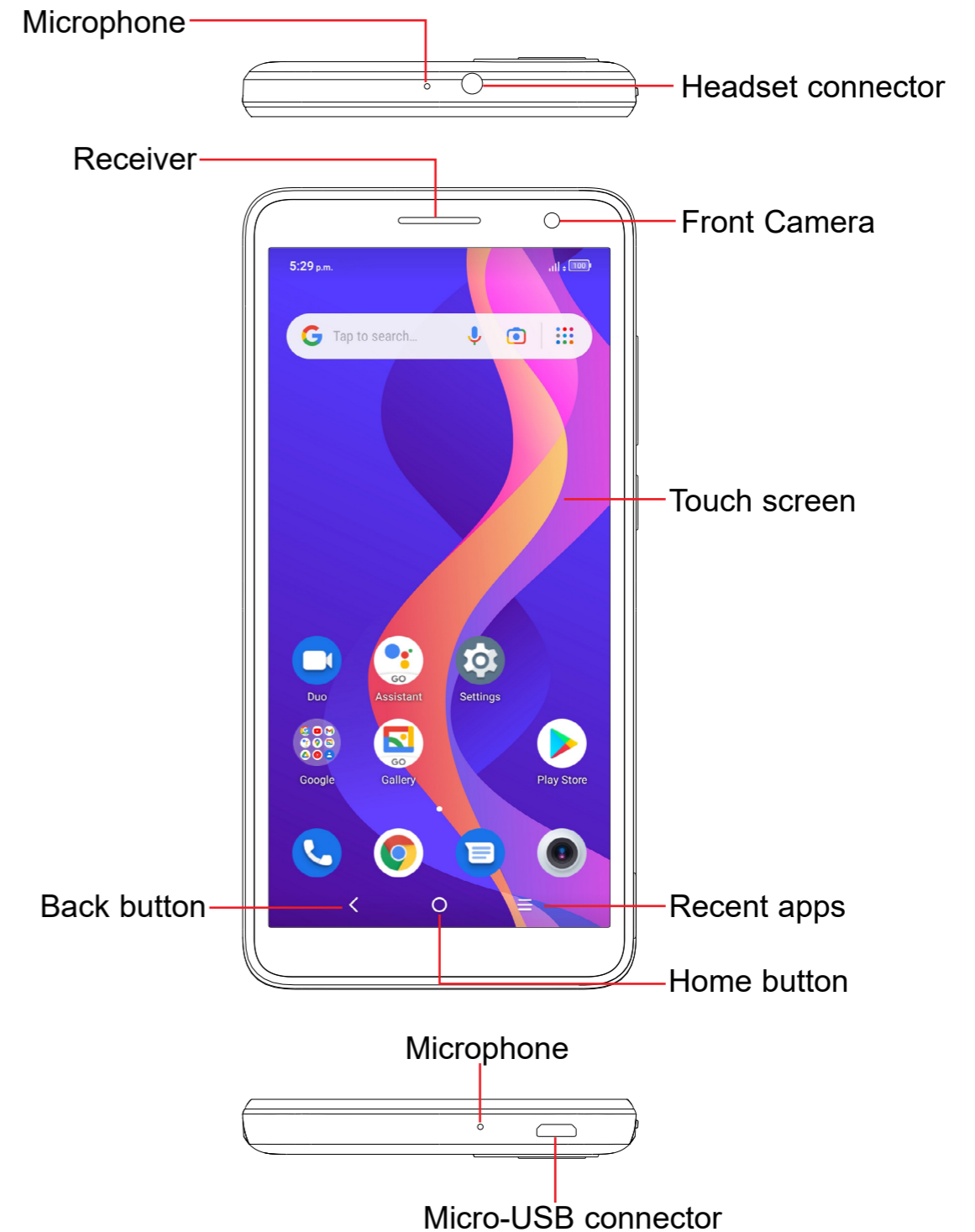

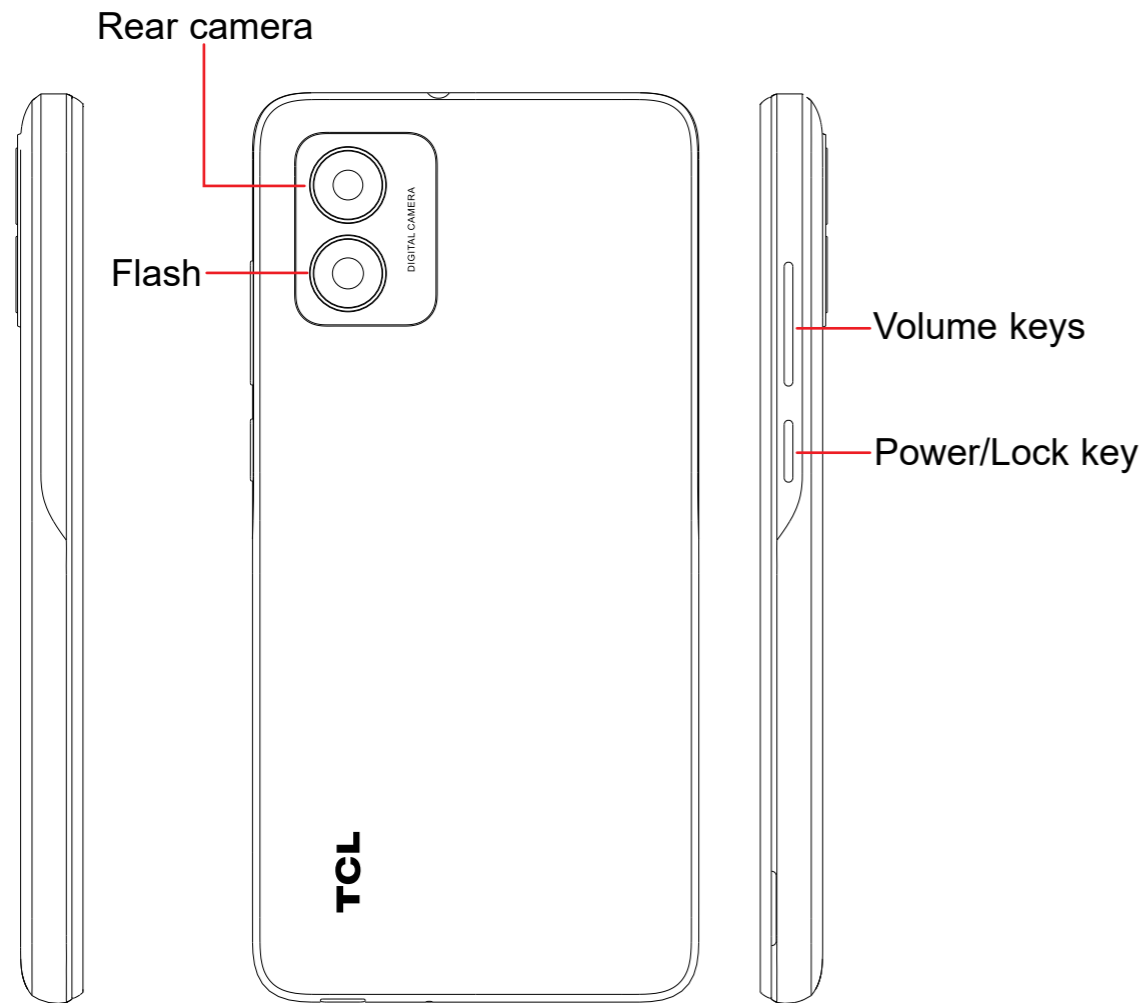

### < Back button

- Tap to return to the previous screen, or to close a dialog box, options menu, the notification panel, etc.

### ○ Home button

- From any application or screen, tap to return to the Home screen.
- Touch and hold to activate Google Assistant. You can get help such as getting directions and restaurant information based on the content detected on the screen.

### ≡ Recent apps

- Tap to view applications you've recently accessed.

### ⏻ Power key

- Press: Lock the screen/Light up the screen.  
**Note:** Additional shortcuts and customizable settings are available at **Settings > Button & gestures > Power key**.
- Press and hold: Show the popup menu to select from **Power off/Restart/Airplane mode**.
- Press the **Power** key and **Volume down** key at the same time to take a screenshot.
- Press and hold the **Power** key for at least 10 seconds to force reboot.

### ⏮ Volume Keys

- Adjusts the earpiece or headset volume during a phone call.
- Adjusts the media volume for streaming, listening, and viewing on media apps.
- Mutes the ringtone of an incoming call.
- While using the camera, press the **Volume up** or **Down** key to take a photo or press and hold to take burst shots. To set, tap **Camera > Settings > Volume button function**.

## 1.2 Getting started

### Setting up

- ① With the phone face down, remove the back cover by gently pulling up on the indentation on the bottom left of the cover.

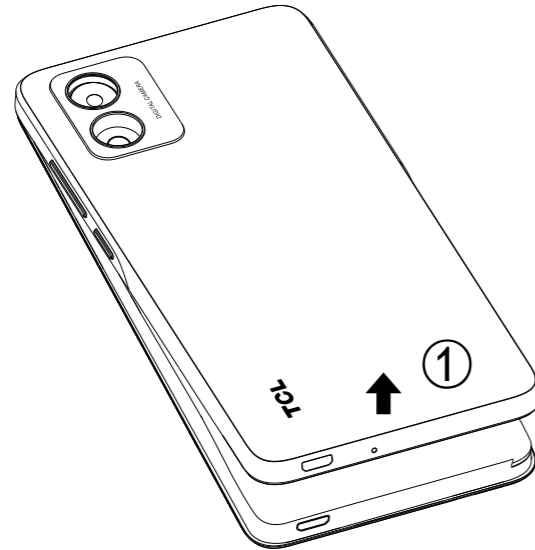

- ② Insert the battery by connecting the gold contacts in the device battery cavity. The battery will only fit one way.

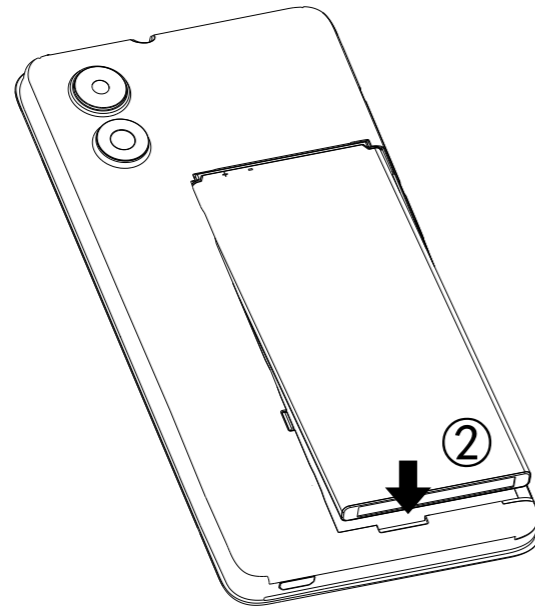

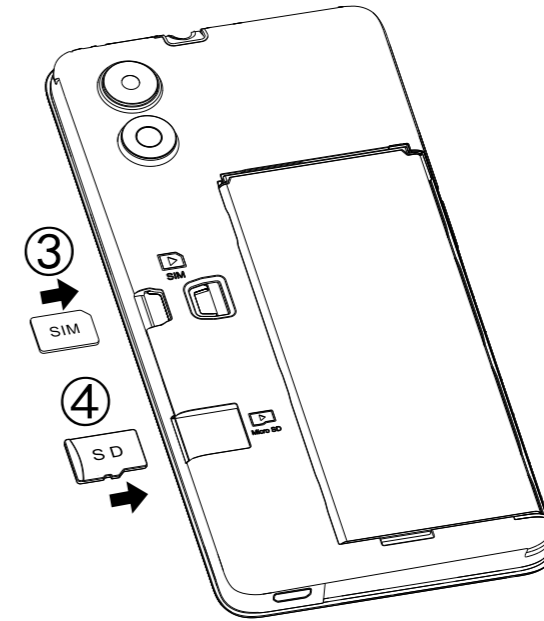

- ③ Place the Nano SIM card into the slot labeled "SIM".
- ④ If applicable, insert the microSD™ card into the slot labeled "Micro SD".

**Note:** microSD™ cards are sold separately. Only use Nano SIM cards with your phone.

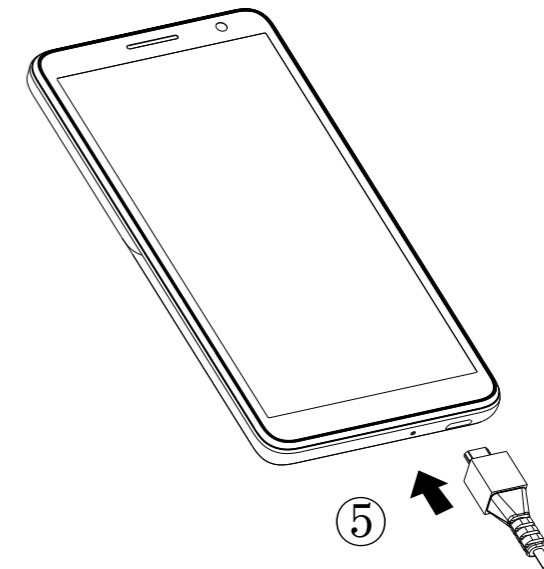

- ⑤ Your new phone is partially charged. Charge the battery by using the Micro-USB cable and charger provided.



Charging status (  ) is indicated by a percentage displayed on screen while the phone is powered off. The percentage increases as the phone is charged.



To reduce power consumption and energy waste when the battery is fully charged, disconnect your charger from the plug; switch off Wi-Fi, GPS, Bluetooth or background-running applications when not in use; reduce the backlight time, etc.

## Powering on your phone

Hold down the **Power** key until the phone powers on, and unlock your phone (Swipe, PIN, Password, Pattern or Face recognition) if necessary and confirm. The Home screen is displayed.

If you do not know your PIN code or forget it, contact your network carrier. Be sure to keep your PIN code secure.

## Powering off your phone

Press and hold the **Power** key until options appear, then select **Power off**.

## 1.3 Home screen

You can bring all the items (applications, shortcuts, folders and widgets) you love or use most frequently to your Home screen for quick access. Tap the **Home** button to switch to the Home screen.

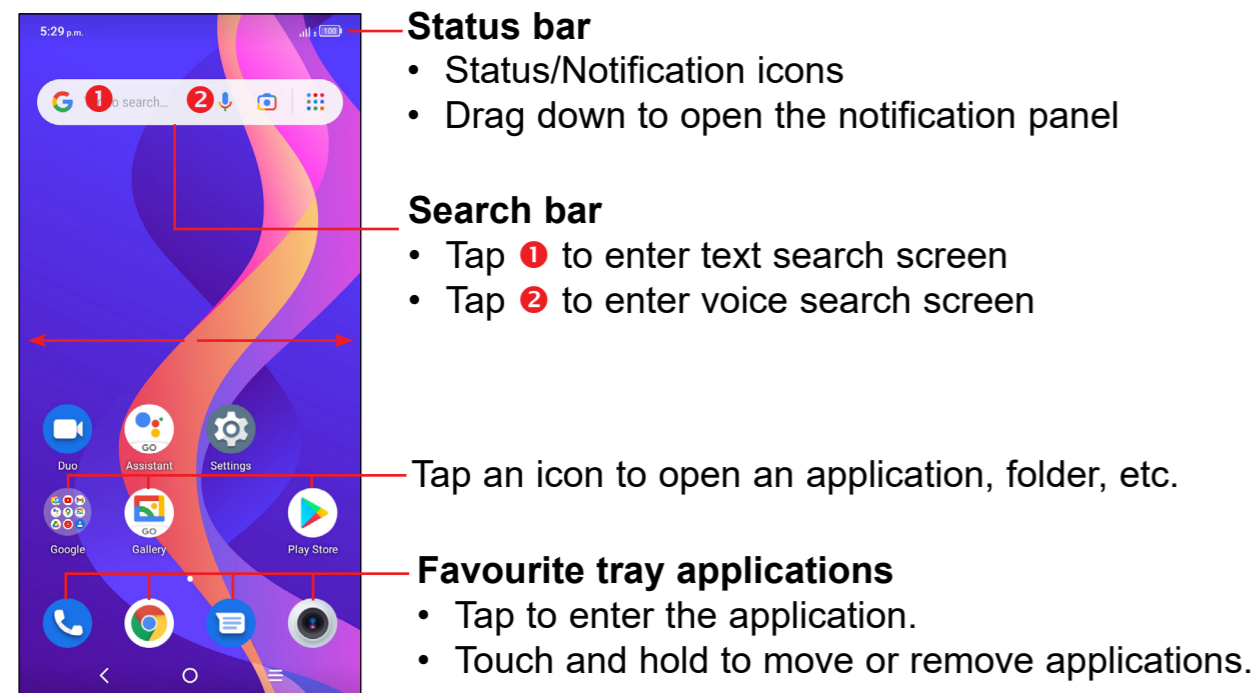

The Home screen is provided in an extended format to allow more space for adding applications, shortcuts etc. Slide the Home screen horizontally left and right to get a complete view.

## Using the touchscreen



**Tap**

To access an application, tap it with your finger.



**Touch and hold**

To enter the available options for an item, Touch and hold the item. For example. Select a contact in Contacts and Touch and hold it. An options list will then appear.



**Drag**

Place your finger on the screen to drag an object to another location.

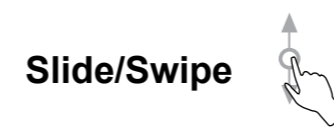

**Slide/Swipe**

Slide the screen to scroll up and down the applications, images, and web pages. You can slide the screen horizontally too.



**Flick**

Similar to swiping, but flicking makes it move quicker.



**Pinch/Spread**

Place two fingers on the screen surface and draw them apart or together to scale an element on the screen.



**Rotate**

Automatically change the screen orientation from portrait to landscape by turning the phone sideways to have a better screen view.

## Status bar

From the status bar, you can view both phone status (on the right side) and notification information (on the left side).

Drag down the status bar to view notifications and drag again to enter the quick settings panel.

Tap and drag up to close it. When there are notifications, they can be accessed by tapping them.

## Notification panel

When there are notifications, tap and drag down the Status bar to open the Notification panel to read more detailed information.

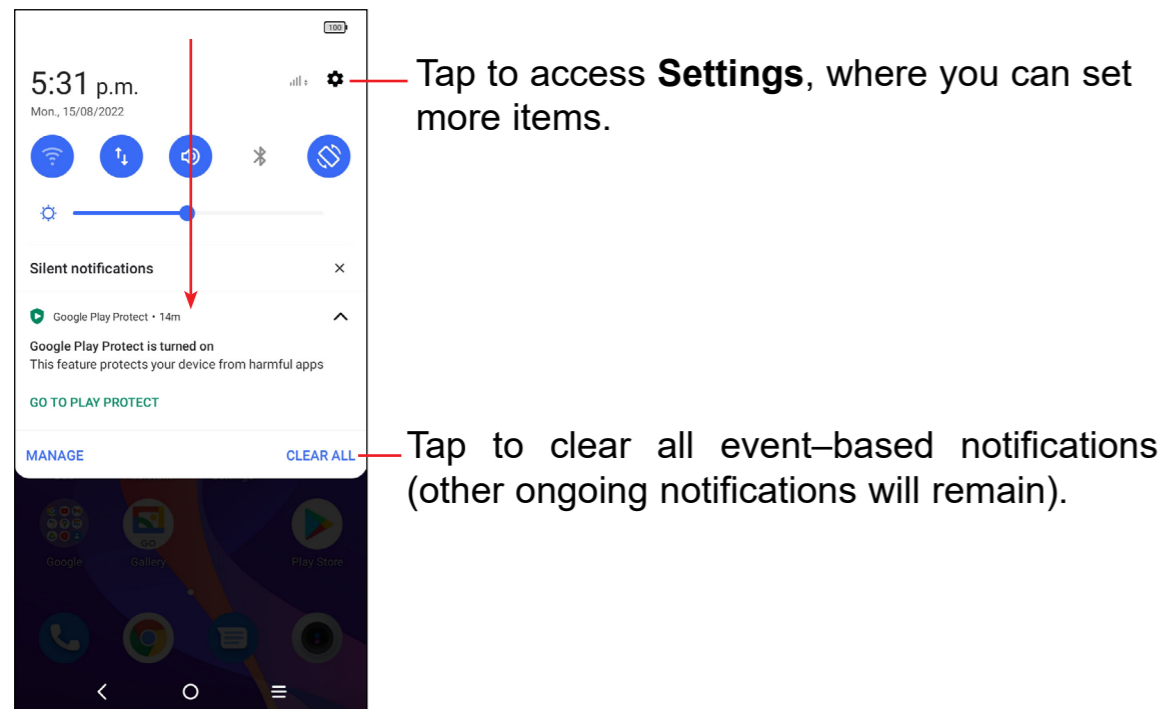

## Quick settings panel

Tap and drag down from the top of the screen twice to open the Quick settings panel.

You can enable or disable functions or change modes by tapping the icons.

Tap the **Edit** icon  to customize your Quick settings panel.

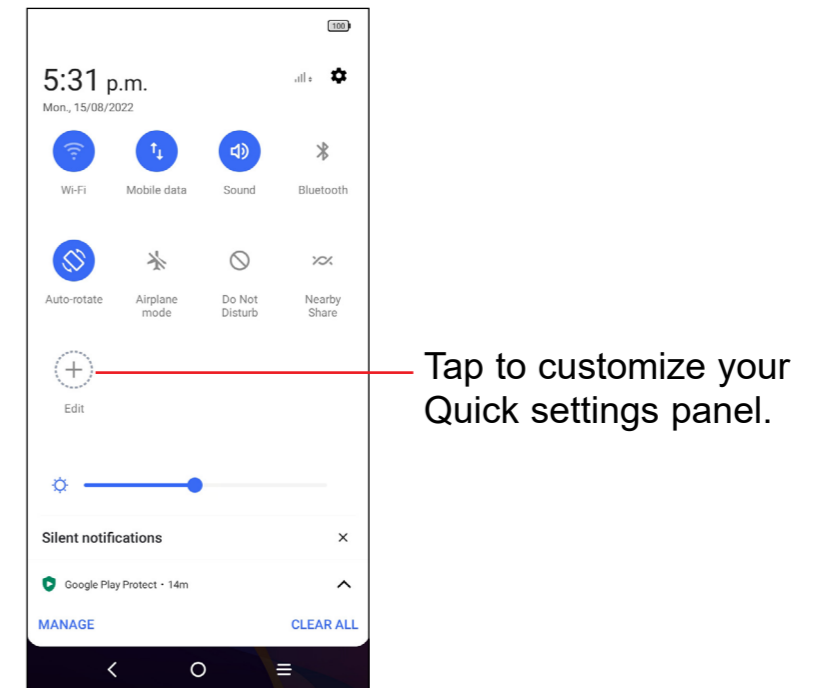

## Lock/Unlock your screen

To protect your phone and privacy, you can lock the screen with a pattern, PIN, password or registered face <sup>(1)</sup>.

To create a screen unlock, tap **Settings** > **Security & biometrics** > **Screen lock** or **Face unlock**.

### To lock the phone screen

- If your phone remains inactive for a period of time, it will automatically lock the screen and enter sleep mode to save power. Go to **Settings** > **Display** > **Sleep** and select a screen timeout period.
- You can also manually lock the screen by pressing the **Power** key once.

<sup>(1)</sup> Face unlock may not be as secure as Pattern, PIN, or Password locks. We may use Face unlock methods only for the purpose to unlock the phone. The data collected from you through such methods will be stored in your device and will not be disclosed to any third-party. You may delete your data anytime.



## Swipe to unlock the screen

Press the **Power** key once to light up the screen, then swipe up on the screen to unlock the screen.

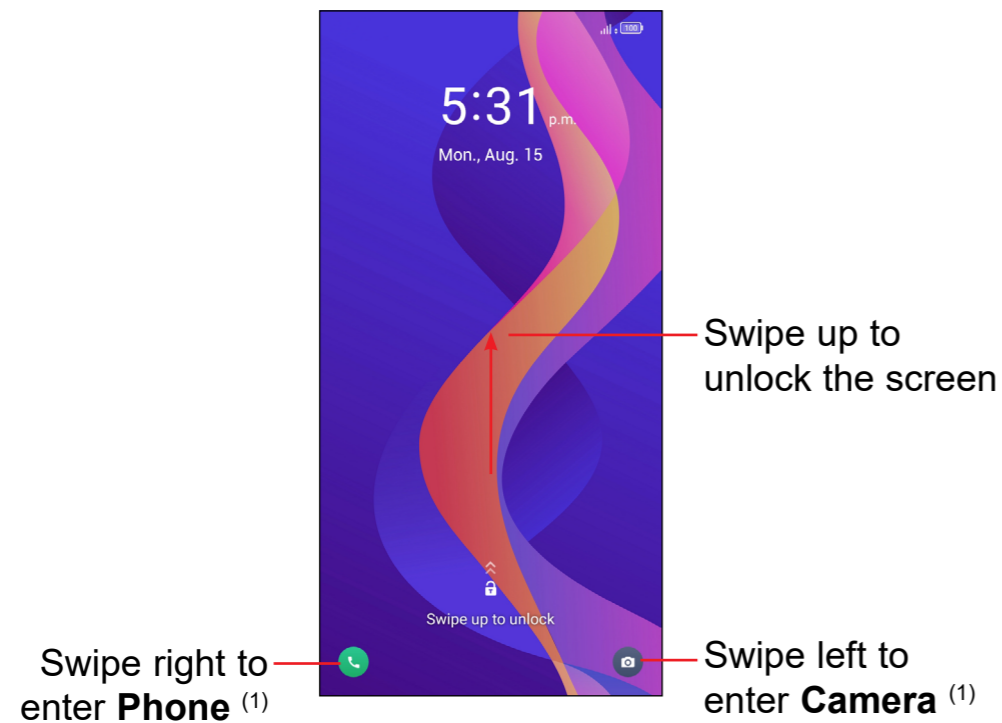

## Enter a password to unlock the screen

Once the screen is turned on, swipe up on the screen to display the password input panel. Then enter your lock screen password.

## Use pattern unlock

Draw the same pattern you have set to unlock the screen.

## Use Face unlock

- From the app list, tap **Settings > Security & biometrics > Face unlock**. Before using the face unlock, you need to set a pattern/PIN/password.
- Hold your phone 20-50 cm from your face. Position your face in the square shown on the screen. For best results, we suggest that the face key should be enrolled indoors and away from direct sunlight.
- Enable Face unlock when your screen turns on, otherwise you will have to swipe up on the screen first of all.

(1) Customized by tapping **Settings > Home screen & lock screen > Lock screen shortcut**.

## Personalizing your Home screen

### Add

You can touch and hold a folder, an application or a widget and drag the item to your preferred Home screen.

### Reposition

Touch and hold an item and drag it to the desired position and then release. You can move items both on the Home screen and the Favourite tray. Hold the icon on the left or right edge of the screen to drag the item to another Home screen.

### Remove

Touch and hold the item and drag it up to the top of the  remove icon, and release after it turns red.

### Create folders

To improve the organization of shortcuts or applications on the Home screen and the Favourite tray, you can add them to a folder by stacking one item on top of another. To rename a folder, open it and tap the folder's title bar to input the new name.

### Wallpaper customization

Touch and hold an empty area on the Home screen, then tap **Wallpapers** to customize wallpaper.

## Shortcuts and recently used applications

### Shortcuts

Touch and hold the empty area in the Home screen, then tap **Shortcuts** to display all shortcuts.

Touch and hold the selected shortcut and slide it to move to your preferred screen.

### Recently used applications

To consult recently used applications, tap the **Recent apps** key.

Tap a thumbnail in the window to open the application.



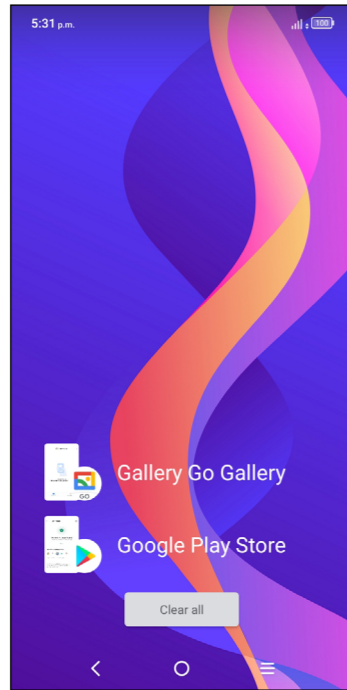



Tap one thumbnail and slide it right to close the application.

Tap **Clear all** at the bottom of the screen to close all the running applications.

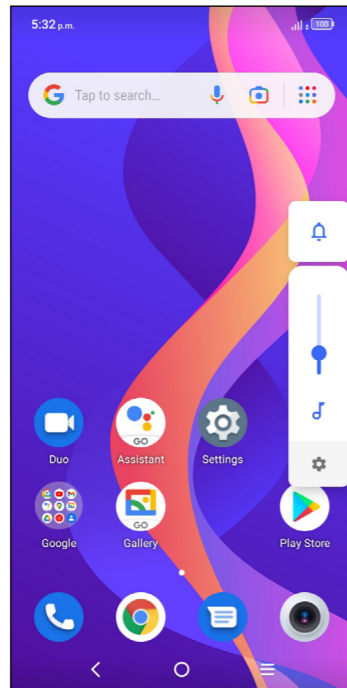
## Volume adjustment



Press the **Volume** key to adjust the Media volume.

Tap  to adjust Ring, Notification volume, Media volume and Alarm.

## 1.4 Text input

### Using the Onscreen Keyboard

#### Onscreen Keyboard settings

Tap **Settings > System > Language & input**, then tap the Virtual keyboard you want to set up and a series of settings will become available.

#### Adjust the Onscreen Keyboard orientation

Turn the phone sideways or upright to adjust the onscreen keyboard orientation. You can adjust it by changing the settings (Tap on/off **Settings > Display > Auto-rotate screen**).

### Android keyboard

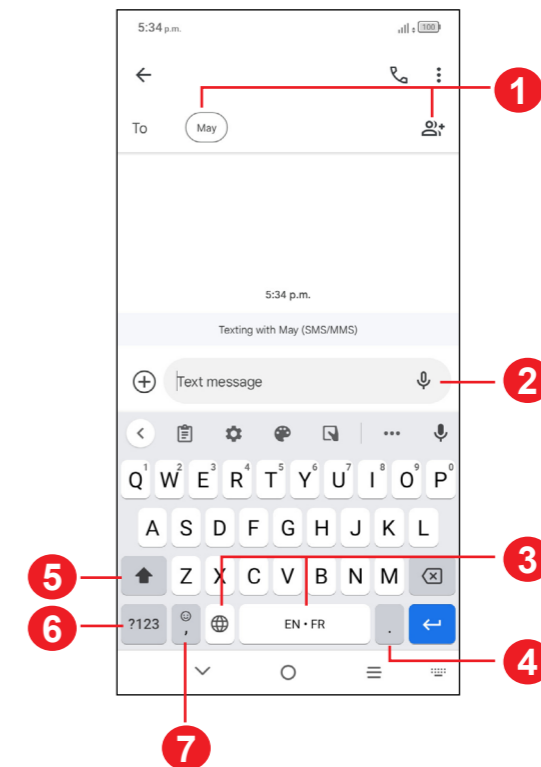

- 1 Enter recipient numbers or select from contacts
- 2 Touch and hold to record audio
- 3 Touch and hold to switch language
- 4 Tap to insert a period  
Touch and hold to select symbols

- 5 Tap to switch between "abc/Abc" mode  
Touch and hold to switch to "ABC" mode
- 6 Tap to access the symbols and numbers keyboards
- 7 Tap to insert a comma  
Touch and hold to access keyboard settings, insert an emoji, or view input options.

## Text editing

### You can edit text which you have entered

- Touch and hold or double tap within the text you want to edit.
- Drag the tabs to change the amount of text to edit.
- The following options will appear: **Cut**, **Copy**, **Paste** and **Share**.

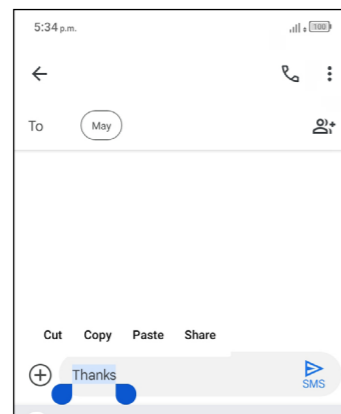

### You can also insert new texts if preferred

- Tap where you want to type, or touch and hold a blank area. The cursor will blink and the tab will appear. Drag the tab to move the cursor.
- If you have cut or copied any text, tap the tab to show the **Paste** and **Select all** option which allows you to complete pasting immediately.

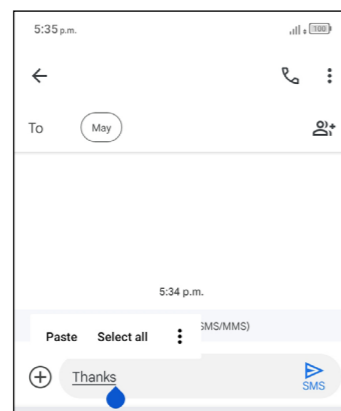

# 2 Multimedia applications

## 2.1 Camera



### Launch Camera

There are multiple ways to open the Camera app.

#### From the Home Screen

From the home screen, tap **Camera** .

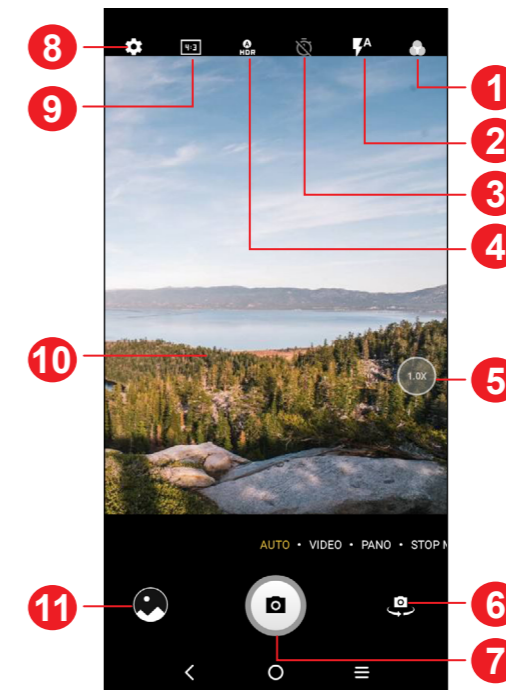

#### From the Lock Screen

When the screen is locked, press the **Power** key once to light up the screen, then swipe left on the camera icon in the lower right corner to open the camera.



- 1 Select filters
- 2 **Flash mode:** Tap to turn on/off the camera flash  
**WARNING:** Keep a safe distance when using the flash. Do not point the flash toward people's or animals' eyes.
- 3 Take a timed photo
- 4 Take HDR photos
- 5 Zoom in/out
- 6 Switch between front/back camera
- 7 Take a photo
- 8 Tap to access settings
- 9 Adjust the Picture size
- 10 Pinch fingers together to zoom out, or spread fingers apart to zoom in
- 11 View the photos or videos you have taken



### To take a photo

The screen acts as the viewfinder. First, position the object or landscape in the viewfinder, then tap the screen to focus if necessary. Tap  to capture. The photo will be automatically saved. You can also touch and hold  to take burst shots.



### To take a video

Tap **VIDEO** to change the camera mode to video.

Tap  to start video recording. Tap  to take a picture during video recording.

Tap  to pause video recording and tap  to continue. Tap  to stop recording. The video will be automatically saved.

### Further operations when viewing a photo/video you have taken

- Slide left or right to view the photos or videos you have taken.
- Tap , then Bluetooth//MMS/Gmail/etc. to share the photo or video.
- Tap  to return to **Camera**.

## Modes and settings

### Modes

Slide left or right to switch between modes.

- **AUTO:** Auto is the default mode for Camera.
- **VIDEO:** Tap to access video mode.
- **PANO:** Tap to turn on the panorama function. Tap the shutter button to start taking a panoramic photo and move the phone steadily along in the direction indicated by the onscreen line. Once the slots are filled, the photo will be automatically saved. If the slots are not fully filled, tap the shutter button again to save the photo.
- **STOP MOTION:** Capture a number of photos of a certain scene, then convert them into a speeded-up video.
- **LIGHT TRACE:** Capture creative movements of light using a long exposure photograph.

### Settings

Tap  to set more options:

- **Photo size:** Select photo size.
- **Video quality:** Select video quality.
- **Volume button function:** Customize the Volume button to Shutter, Zoom or Volume when using camera.
- **Storage:** Choose between phone and microSD™ card storage when an microSD™ card is inserted. The default is phone storage.
- **Save location information:** Tag photos and videos with your location. This option is available when the GPS location service is enabled.
- **Shutter sound:** Turn on/off shutter sound when capturing.
- **Reset settings:** Reset the camera to its factory default settings.

## 2.2 Gallery .....



Gallery acts as a media player for you to view photos and play videos. It also automatically analyses photos and organises them into groups, so that you can quickly locate the photos you need.

To view, edit or share the photos/videos, tap **Gallery**  from the Home screen.

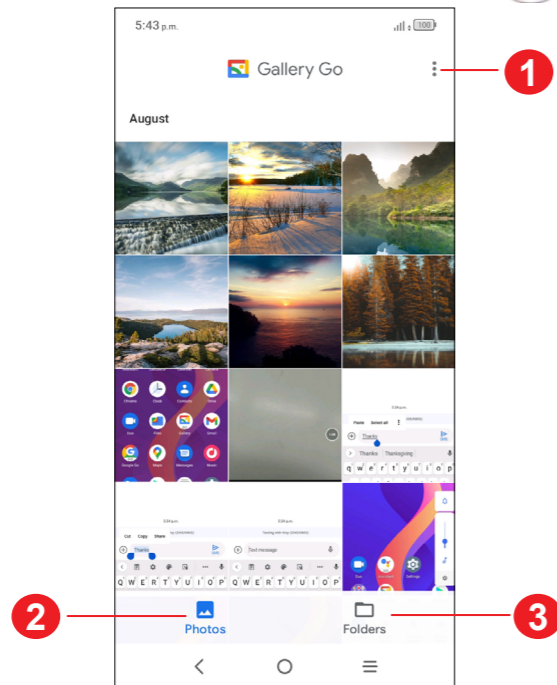

1 Tap to access more options

2 **Photos**

View the photos/videos you have just taken

3 **Folders**

Photos, videos, screenshots, etc. are all automatically grouped in Folders

### Working with pictures and videos

You can work with pictures by rotating or cropping them, sharing them with friends, setting them as a contact photo or wallpaper, etc.

Find the picture you want to work on, and tap the picture in the full-screen picture view.

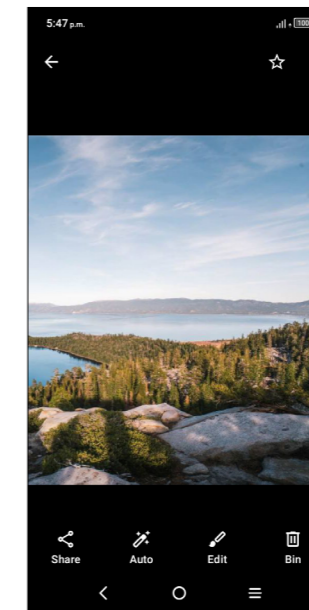

Tap  to add filter to the picture.

Tap  to share the picture.

Tap  to edit the picture.

Tap  to delete the picture.

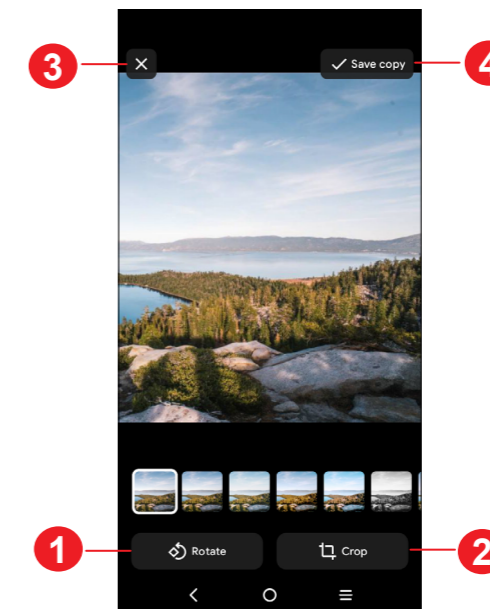

1 Rotate

2 Crop

3 Discard changes

4 Save changes



- **To edit a video**

Tap the video in the full-screen view and tap .

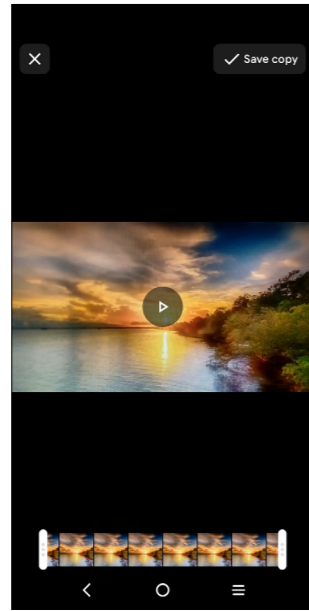



Drag the slider at both ends of the video crop area to select the video portion you want to keep. Tap  to preview. Once done, tap **Save copy**.

### Folder management

Create folders to conveniently manage and view your pictures and videos.

- Create a folder

Tap  > **New folder** to create and name a new folder. Select the pictures or videos you want to include in it by tapping  to copy or move them.

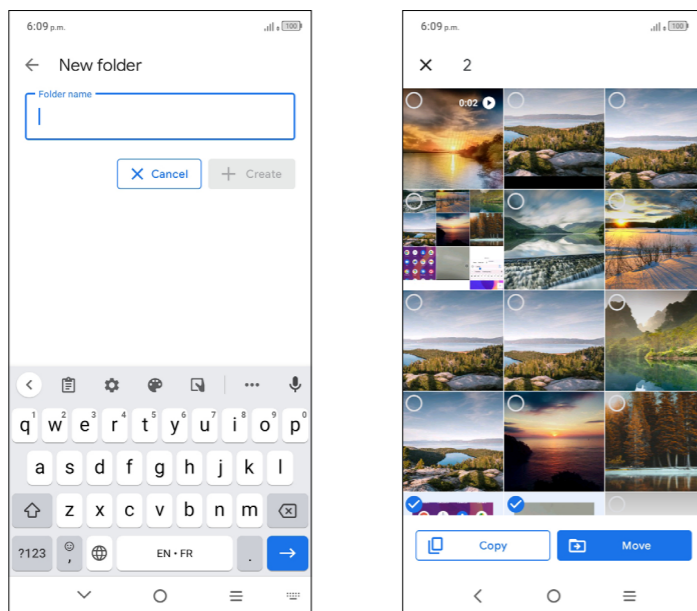

- Move/copy pictures or videos

Touch and hold the picture(s) or Video(s) you want to move/copy, Tap  > **Move to folder/Copy to folder**, then select the folder that you want to move to/copy to.

- Delete pictures or videos

Touch and hold the picture(s) or Video(s) you want to delete, tap .

## 2.3 Music



You can play music files stored on your phone or microSD™ card.

To play a music file, swipe up on the Home screen, then tap Music .

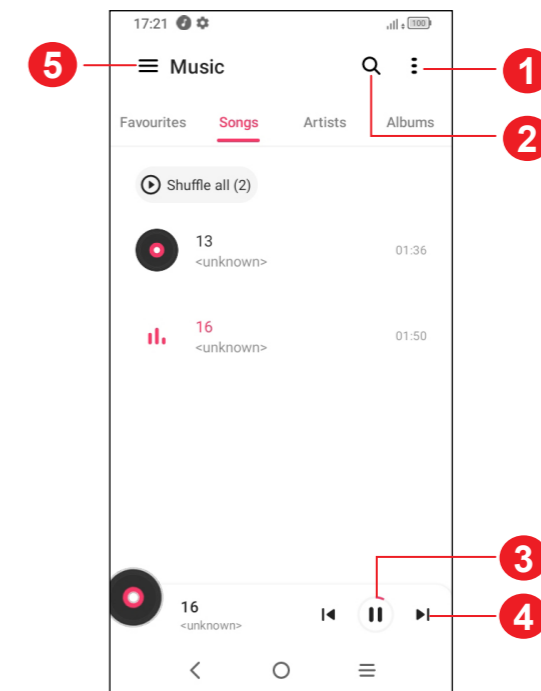

- 1 More options
- 2 Search for a song
- 3 Play or pause
- 4 Play the next song
- 5 Music settings

 While playing songs with Music, the operation of pause, play or skip is still available even if the screen is locked.

# 3 Apps and features

## 3.1 Phone



### Making a call

To make a call, tap  in the Favourites tray.

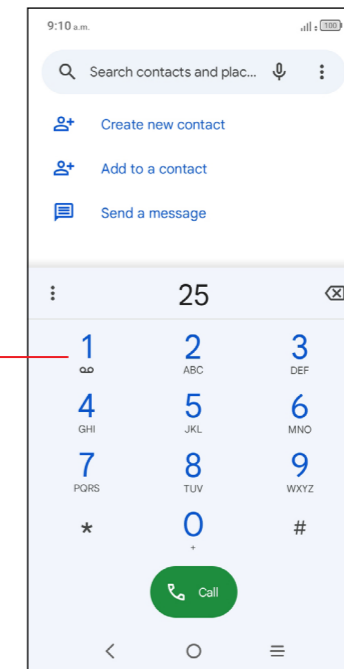
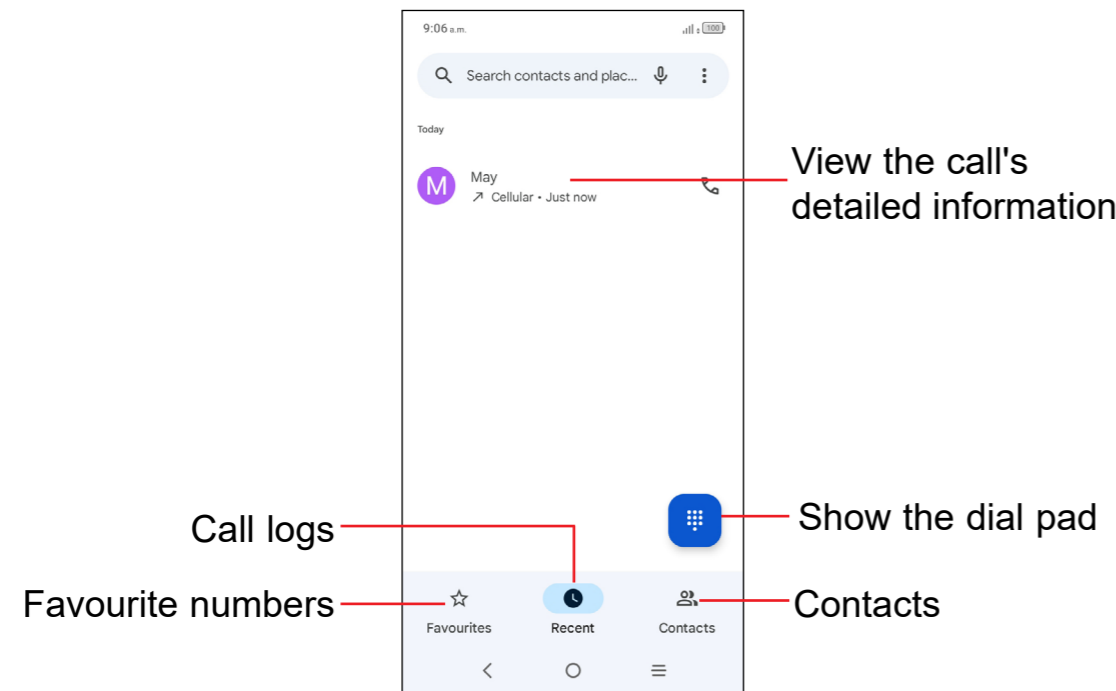



Enter the desired number from the dial pad and tap  to place the call or select a contact from **Contacts** or **Call logs** by sliding or tapping tabs, then make the call.

The number you entered can be saved to **Contacts** by tapping **Create new contact** or **Add to a contact**.

If you make a mistake, you can delete the incorrect digits by tapping .

To hang up a call, tap .

### International call

To dial an international call, touch and hold  to enter "+", then enter the international country prefix followed by the full phone number and tap .

### Emergency call

If your phone has network coverage, dial the emergency number and tap  to make an emergency call. Depending on your network and country this could even work without a SIM card and without typing in the SIM PIN code.



## Answering or rejecting a call

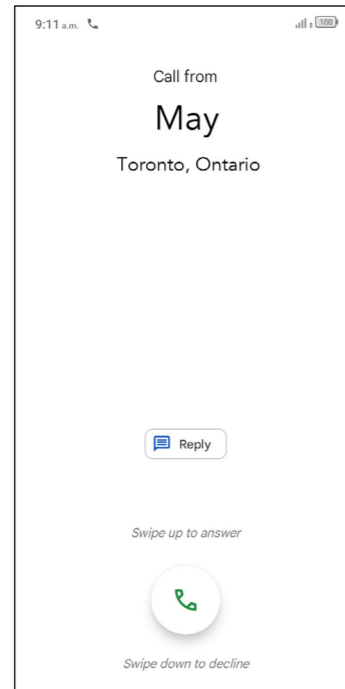

When you receive a call:

- Swipe up to answer;
- Swipe down to reject;
- Tap  Reply to reject the call by sending a preset message.

## Calling your voicemail





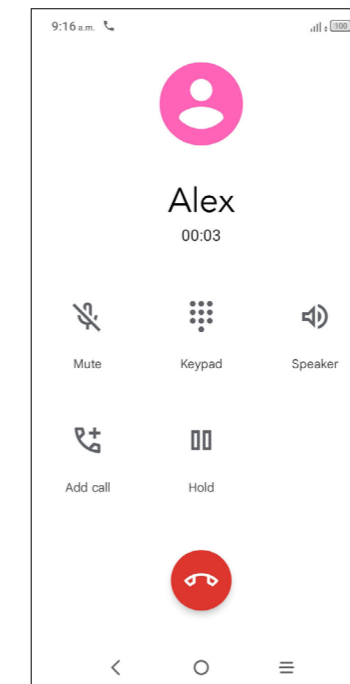

To access your voicemail, press and hold  1.

If you receive a voicemail,  appears on the Status bar. Open the Notification panel and tap **New voicemail**.

## During a call

To adjust the volume during a call, press the **Volume up/down** key.



-  End the current call.
-  Tap to mute the current call. Tap this icon again to unmute the call.
-  Display the dial pad.
-  Tap to activate the speaker during the current call. Tap this icon again to deactivate the speaker.
-  Make another call.
-  Put a call on hold.
-  To avoid accidental operation of the touchscreen during a call, the screen will be locked automatically when you put the cellphone close to your ear; and it will be unlocked when the cellphone is taken away from your ear.

## Managing multiple calls





With this phone you can handle multiple calls at the same time.

### Swap calls

When you accept two calls, tap  to switch between two lines. The current call will be put on hold and you are able to join the other call.

### Conference calls<sup>(1)</sup>

You can set up a conference call as follows.

- Place a call to the first participant of the conference call.
- Tap  to add another call.
- Enter the phone number of the person you want to add to the conference and tap . You can also add participants from **Call logs** or **Contacts**.
- Tap  to start the conference.
- Tap  to end the conference call and disconnect all callers.

## Call settings

Tap  from the **Phone** screen, then tap **Settings** to set phone and contact settings.

## Call log

You can access your call logs by tapping  from the **Phone** screen to view missed calls, outgoing calls and incoming calls.

Tap one call to view information or further operations. You can launch a new call, send a message to the contact or number, or view detailed information of the call.

To delete the call history of a selected contact or number, touch and hold the contact and choose **Delete**.

<sup>(1)</sup> Depending on your network carrier.

## 3.2 Contacts .....



**Contacts** enables quick and easy access to the contact you want to reach.

You can view and create contacts on your phone and synchronize with your Gmail contacts or other applications on the web or on your phone.

## Consult your Contacts

To see your contacts, swipe up on the Home screen, then tap .

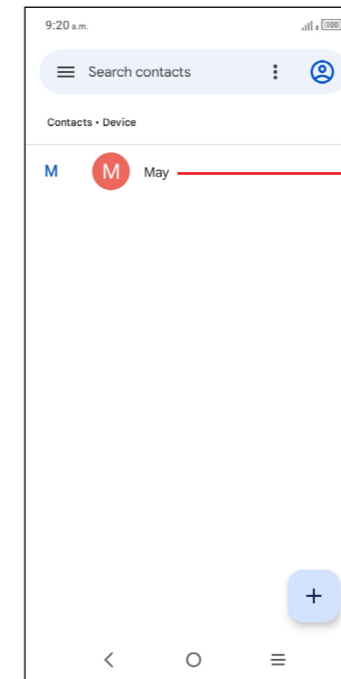

- Tap to open the Quick contact panel
- Touch and hold to share or delete the selected contact

Add new contact



Deleted contacts will also be removed from other applications on the phone or web the next time you synchronize your phone.

## Adding a contact

Tap **+** in the contact list to create a new contact.

You are required to enter the contact's name and other contact information. By scrolling up and down the screen, you can move from one field to another.

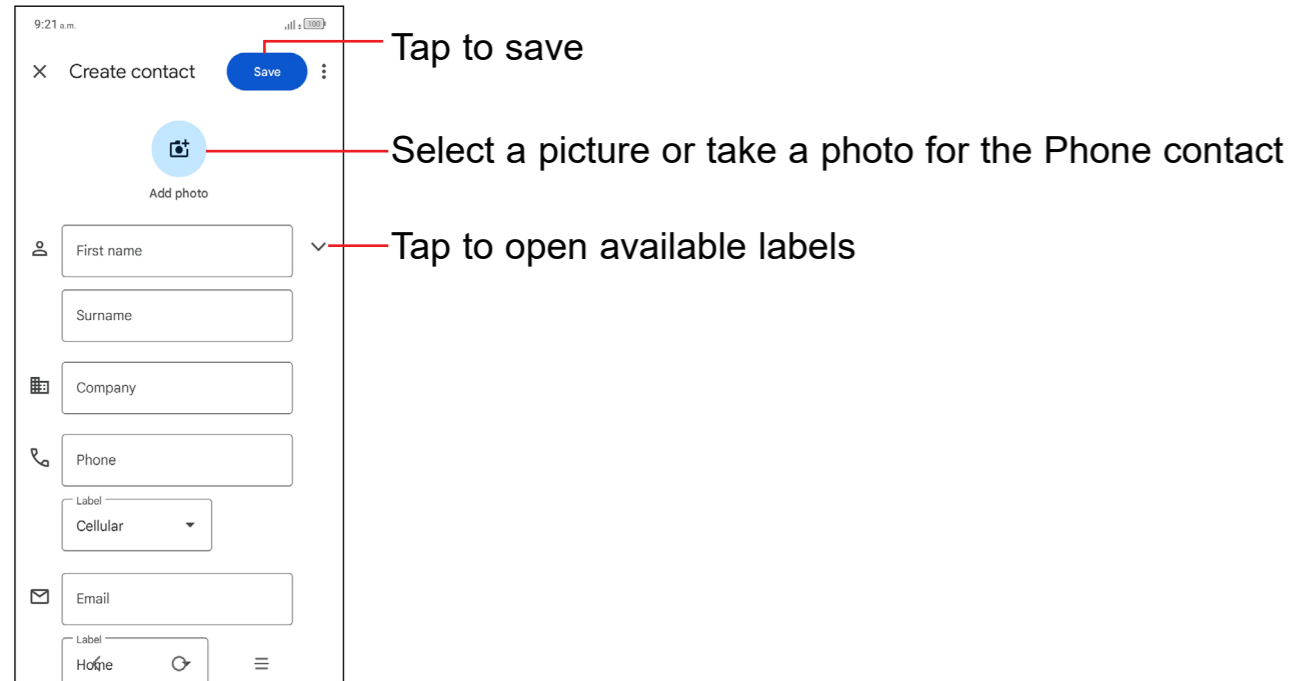

### Add to/remove from Favourites <sup>(1)</sup>

To add a contact to favourites, you can tap a contact to view details then tap  to add the contact to favourites.

To remove a contact from favourites, tap  on the contact details screen.

## Editing your contacts

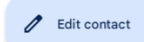
To edit contact information, tap  on the contact details screen.



When finished, tap **Save**.

<sup>(1)</sup> Phone and Gmail contacts can be added to favourites.

## Using the Quick contact panel

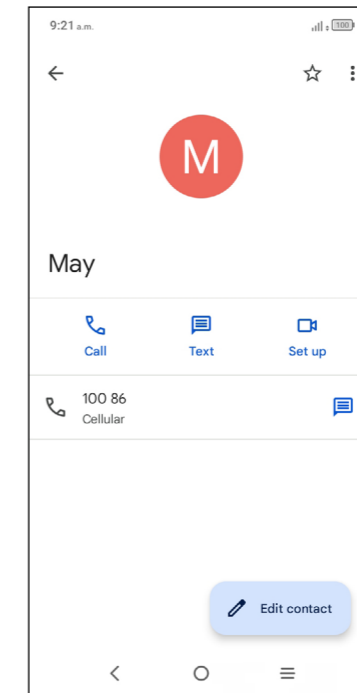
Tap a contact to open the Quick contact panel.



- Tap  or the number to make a call.
- Tap  to send a message.
- Tap  to make a video call.

The icons available on the Quick contact panel depend on the information you have for the contact and the applications and accounts on your phone.

## Sharing contacts

You can share contacts with others by sending the contact's vCard to them via Bluetooth, Gmail, etc.

- From the Contacts screen, touch and hold a contact and tap .
- Select the application to perform this action.

## Accounts

Contacts, data or other information can be synchronized from multiple accounts, depending on the applications installed on your phone.

To add an account, tap  from the contacts list and tap **Settings > Accounts > Add account**, or from the home screen, tap **Settings > Users & accounts > Add account**.

You are required to select the type of account you are adding, like Google, etc.

You may need to enter detailed information, like username, password, etc when setting up any other accounts.

You can remove an account and all associated information from the phone. Tap the account you want to delete, then tap **Remove account** and confirm.

## Auto-sync

On the **Accounts** screen, turn on **Automatically sync data** . When activated, all changes of information on the phone or online will be automatically synchronized with each other.

## 3.3 Messages



### Writing a new message

You can create, edit and receive SMS and MMS with this phone.

To access Messages, tap .

On the message list screen, tap  to write text/multimedia messages.

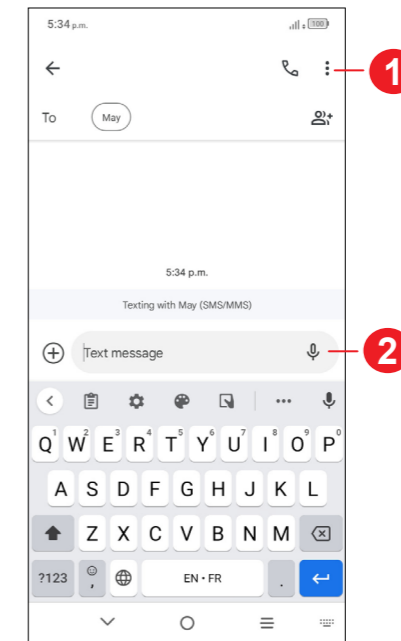

1 More options

2 Send the message

### Sending a text message



- To add recipients, enter a mobile phone number or select a contact in the **To** bar.
- Tap the **Text message** bar to enter the text of the message.
- When finished, tap  to send the text message.

 Specific letters (accented) will also increase the size of the SMS. This may cause multiple SMS to be sent to your recipient.

## Sending a multimedia message

MMS enables you to send video clips, images, photos, animations, slides and sounds to other compatible mobiles and email addresses.

An SMS will be converted to MMS automatically when media files (image, video, audio, etc.) are attached or subject or email addresses are added.

- To send a multimedia message, enter the recipient's phone number in the **To** bar.
- Write the text of the message in the **Text** bar.
- Tap  to attach emojis, picture, video, etc.
- Touch and hold  to record audio.
- When finished, tap  to send the multimedia message.

## Manage messages

When a message is received,  will appear on the Status bar as a notification. Swipe down the Status bar to open the Notification panel. Tap the new message to open and read it. You can also access the **Messages** application and tap the message to open it.

Messages are displayed as a conversation.

Tap a message to enter the message composing screen:

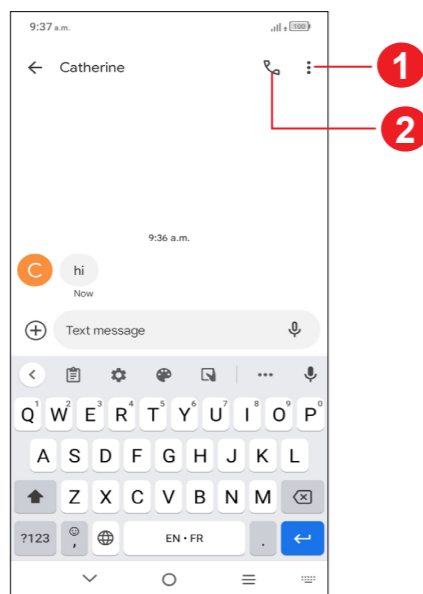

- 1 Tap for more options
- 2 Tap to call the number

To adjust message settings, tap  and select Settings on the message list screen.

## 3.4 Calendar .....



Use **Calendar** to keep track of important meetings, appointments, etc.



To view the calendar and create events, open the Google apps folder from the Home screen, then tap **Calendar**.

### Multimode view

You can display the Calendar by **Schedule**, **Day**, **3 days**, **Week**, or **Month**, tap  to select.



### To create new events

You can add new events from any Calendar view.

- Tap .
- Fill in all required information for this new event. If it is a whole-day event, you can turn on **All-day** .
- Invite guests to the event. Enter the email addresses of the guests you want to invite. The guests will receive an invitation from Calendar and Email.
- When finished, tap **Save** at the top of the screen.

To quickly create an event from the Day, 3 days and Week view screens, tap an empty spot to select a target area, then tap again to create a new event.

### To delete or edit an event

To delete or edit an event, tap the event to enter its details screen. Tap  to edit the event, or tap  > **Delete**.

### Event reminder

If a reminder is set for an event, the upcoming event icon  will appear on the Status bar as a notification when the reminder time arrives.

Tap and drag down the Status bar to open the notification panel, tap an event name to view the Calendar notification list. Tap the **Back** button to keep the reminders pending in the Status bar and the notification panel.

## 3.5 Clock.....



Your mobile phone has a built-in clock.

To view the current time, swipe up on the Home screen, then tap **Clock**.

### Alarm

From the Clock screen, tap **Alarm** to enter.

- Turn on to enable the alarm.
- Tap to add a new alarm, and tap to save.
- Tap an existing alarm to enter the alarm editing screen.
- Tap **DELETE** and confirm to delete the selected alarm.

### Clock

To view the date and time, tap **Clock**.

- Tap to add a city from the list.

### Timer

From the Clock screen, tap **Timer** to enter.

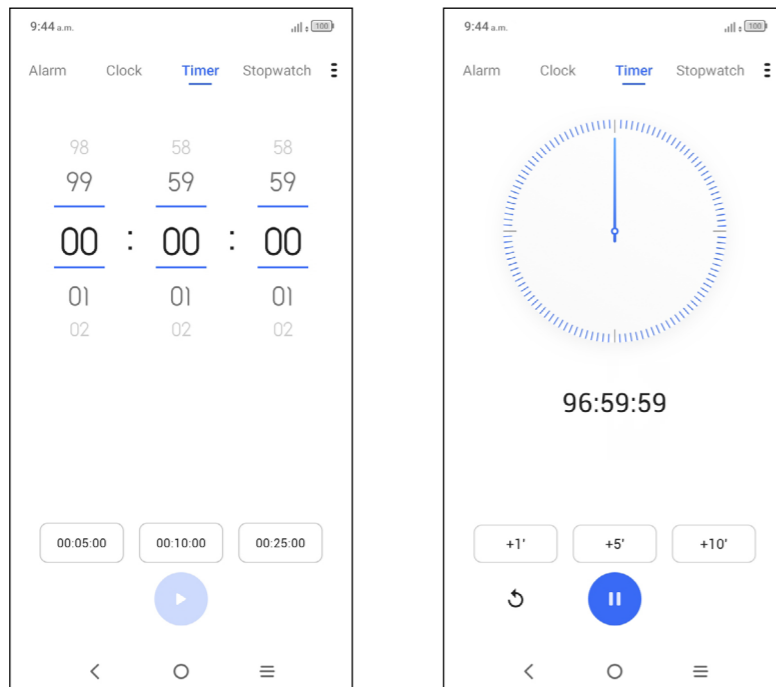

- Tap the provided time to start the countdown directly.

- Set the time. Tap to start the countdown.
- Tap to pause.
- Tap to reset.

### Stopwatch

From the Clock screen, tap **Stopwatch** to enter.

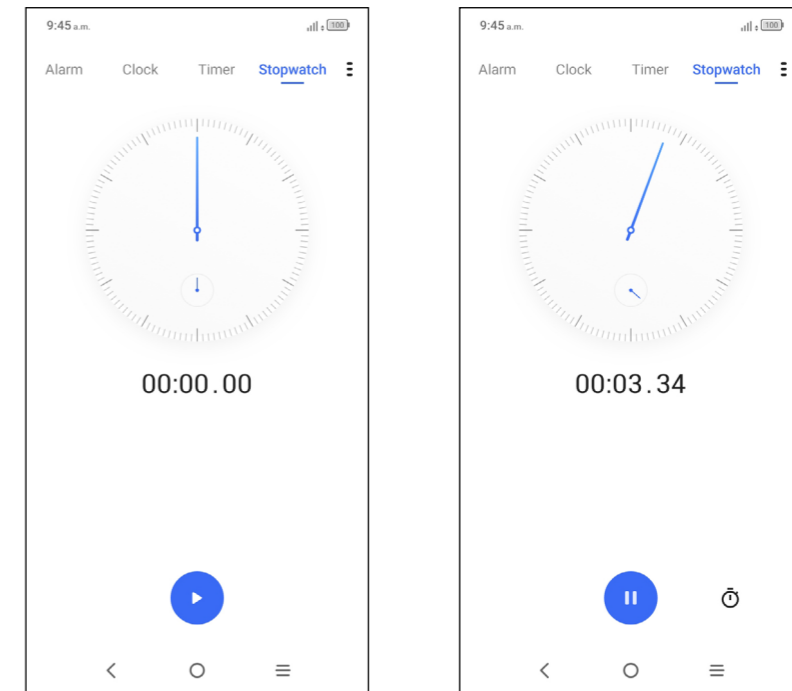

- Tap to start the Stopwatch.
- Tap to pause.
- to reset.
- to share.

### Adjust Clock settings

Tap to access Clock and Alarm settings.



### 3.6 Calculator.....



To solve mathematical problems with **Calculator**, swipe up from the home screen, then tap .

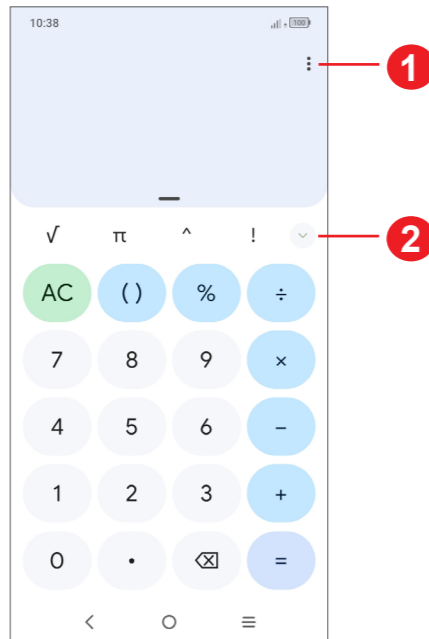

- 1 More options
- 2 Tap to switch between Basic calculation and Scientific calculation

### 3.7 TCL apps

#### Support Center .....



Support Center helps you to learn more about Hot FAQs, operation instructions, troubleshooting, etc. Use it to send us your feedback.

### 3.8 Other applications <sup>(1)</sup>

The previous applications in this section are preinstalled on your phone. To download and install more 3rd party applications, use the Google Play Store application.

<sup>(1)</sup> Application availability depends on country and carrier.

### 3.9 Google applications

Google apps are preinstalled on your phone to improve work efficiency and help you enjoy life.

This manual briefly introduces the apps. For detailed features and user guides, refer to the related websites or the introduction provided in the apps.

You are recommended to register with a Google account to enjoy all the functions.

#### Chrome

Surf the web using the Chrome browser.

Your bookmarks, browsing history, and settings across all devices with the browser installed can be synchronized with your Google account.

#### Gmail

As Google's web-based email service, Gmail is configured when you first set up your phone. With this application you can send and receive emails, manage emails by labels, archive emails, etc. Emails can be automatically synchronized with your Gmail account.

#### Maps

Google Maps offers satellite imagery, street maps, 360° panoramic views of streets, real-time traffic conditions, and route planning for traveling by foot, car, or public transportation. By using this application, you can find your own location, search for a place, and get suggested route planning for your trips.

#### YouTube

YouTube is an online video-sharing application where users can upload, view, and share videos. Available content includes video clips, TV clips, music videos, and other content such as video blogging, short original videos, and educational videos. It supports a streaming function that allows you to start watching videos almost as soon as they begin downloading from the internet.

## Play Store

Serves as the official app store for the Android operating system, allowing users to browse and download applications and games. Applications are either free of charge or at a cost.

In Play Store, search for the app you need, download it and then follow the installation guide to install the app. You can also uninstall, update an app, and manage your downloads.

## Duo

A video chat mobile app.

With phone numbers verified, users can easily video call people from their contact list.



## Google Assistant

Touch and hold the **Home** button, or say, “Hey Google”, to quickly ask for help, check the news, make a phone call, and more.

## Files

Files displays all data stored on the phone, including both external microSD™ card and internal storage, such as applications, media files downloaded from Google Play Store, YouTube or other locations; Videos, pictures or audios you have captured; other data transferred via Bluetooth, USB cable, etc.

# 4 Settings.....

To go to **Settings**, tap  from the Home screen or swipe up from the Home screen and then tap .

You can also swipe down from the notification panel and tap  to access **Settings**.

## 4.1 Wi-Fi

You can connect to the internet when your phone is within range of a wireless network. Wi-Fi can be used on your phone even without a SIM card inserted.

### To turn Wi-Fi on and connect to a wireless network

- Tap **Settings > Wi-Fi > tap**  to turn on.
- Once Wi-Fi is turned on, detected Wi-Fi networks are listed.
- Tap a Wi-Fi network to connect to it. If the network you selected is secured, you are required to enter a password or other credentials (you should contact the network carrier for details). When finished, tap **Connect**.

### To add a Wi-Fi network

When Wi-Fi is on, you can add new Wi-Fi networks according to your preference.

- Tap **Settings > Wi-Fi > Add network**.
- Enter the name of the network and any required network information.
- Tap **Connect**.

### To forget a Wi-Fi network

The following steps prevent automatic connection to networks which you no longer wish to use.

- Turn on Wi-Fi, if it's not already on.
- On the Wi-Fi screen, tap the name of the saved network.
- Tap **FORGET** in the dialog that opens.

## 4.2 Bluetooth

Bluetooth is a short-range wireless communication technology that you can use to exchange data, or connect to other Bluetooth devices for various uses.

### To turn on Bluetooth

- Tap **Settings** > **Bluetooth** > tap  to turn on.

Your device name and other available devices will appear on screen.

### To rename your device

- Tap **Settings** > **Bluetooth**.
- Tap **Device name**.
- Enter a name, and tap **RENAME** to confirm.

### To pair/connect your phone with a Bluetooth device

To exchange data with another device, you need to turn Bluetooth on and pair your phone with the Bluetooth device with which you want to exchange data.

- Tap **Settings** > **Bluetooth** > **+ Pair new device**.
- Tap a Bluetooth device you want to pair your phone with in the list.
- In the dialog that pops up, tap **PAIR** to confirm.
- If the pairing is successful, your phone will be connected to the device.

### To unpair from a Bluetooth device

- Tap  beside the device you want to unpair from.
- Tap **FORGET** to confirm.

## 4.3 SIM card & cellular network

### Cellular network

In this menu, you can enable data roaming, select your preferred network type, check the network connection you are using or create a new access point, etc.

### Data usage

The first time you turn on your phone with your SIM card inserted, it will automatically configure your network service: 2G, 3G, 4G<sup>(1)</sup>.

### Data saver

By enabling Data saver, you can reduce data usage by preventing some apps from sending or receiving data in the background.

### Cellular data

If the network is not connected, you can turn on Cellular data in **Settings** > **SIM card & cellular network** > **Data usage**.

If you do not need to transmit data on cellular networks, turn off **Cellular data** to avoid incurring significant charges for data use on local carrier cellular networks, particularly if you do not have a cellular data agreement.



Data usage is measured by your phone, and your carrier may count differently.

### App data usage

Tap to review the data usage of each app.



Carrier data accounting may differ from device accounting.

### Billing cycle

Tap to set the cellular data usage cycle.

### Wi-Fi data usage

Tap to review Wi-Fi data usage.

<sup>(1)</sup> Network availability is dependant on your cellular carrier.

## Network restrictions

You can set metered Wi-Fi networks.

Metered networks are treated like cellular networks when background data is restricted. Apps may warn before using these networks for large downloads.

## Airplane mode

Turn on **Airplane mode** to simultaneously disable all wireless connections including Wi-Fi, Bluetooth and more.

## Tethering

To share your phone's data connection via Wi-Fi, Bluetooth, USB and Ethernet tethering, or as a mobile hotspot, go to **Settings > SIM card & cellular network > Tethering** to activate these functions.

### To rename or secure your mobile hotspot

When your mobile hotspot is activated, you can rename your phone's Wi-Fi network (SSID) and secure its Wi-Fi network.

- Tap **Settings > SIM card & cellular network > Tethering > Mobile hotspot**.
- Tap **Hotspot name** to rename the network SSID and tap **Hotspot password** to set your network security.
- Tap **OK**.



The functions above may incur additional network charges from your network carrier. Extra fees may also be charged in roaming areas.

## Private DNS

Tap to select private DNS mode.

## 4.4 Connected devices

### VPN

Virtual private networks (VPNs) allow you to connect to the resources inside a secured local network from outside that network. VPNs are commonly deployed by corporations, schools, and other institutions so that their users can access local network resources when not inside that network, or when connected to a wireless network.

#### To add a VPN

- Tap **Settings > Connected devices > VPN** and then tap .
- On the screen that opens, follow your network administrator's instructions to configure each component of the VPN settings.
- Tap **SAVE**.

The VPN is added to the list on the VPN settings screen.

#### To connect to/disconnect from VPN

To connect to a VPN:

- Tap **Settings > Connected devices > VPN**.
- The VPNs you have added are listed. Tap the VPN you want to connect with.
- In the dialog that opens, enter any requested credentials and tap **CONNECT**.

To disconnect from a VPN:

- Tap the VPN you want to disconnect from. In the dialog that opens, tap **DISCONNECT**.

#### To edit/delete a VPN

To edit a VPN:

- Tap **Settings > Connected devices > VPN**.
- The VPNs you have added are listed. Tap the  icon next to the VPN you want to edit.
- After editing, tap **SAVE**.

To delete a VPN:

- Tap the  icon next to the selected VPN, then tap **FORGET** to delete it.

## USB connection

With a USB cable, you can charge your device, transfer files or photos (MTP/PTP) between your phone and a computer.

### To connect your phone to the computer

- Use the USB cable that came with your phone to connect the phone to a USB port on your computer. You will receive a notification that the USB is connected.
- Open the Notification panel and choose the way which you want to transfer files or tap **Settings > Connected devices > USB connection** to select. By default, **Charge this device** is selected.



Before using MTP, make sure that the driver (Windows Media Player 11 or higher version) has been installed.

## Printing

Tap **Printing** to activate Print services. You can select your **Default print service**.

## Nearby Share

This feature allows you to share files on your device with nearby devices. You may choose to limit your visibility to stored Contacts on your device, or open to any device nearby. Tap  to enable.

Before using Nearby Share, please be ensure that:

- At least one account (Google, Yahoo, Exchange, etc.) is linked to your device and logged in.
- Bluetooth and Location settings are switched on.
- A temporary Wi-Fi hotspot is switched on in order to share files.

## 4.5 Home screen & lock screen

With this menu, set your home apps, choose your favourite wallpapers and theme styles, etc.

## 4.6 Display

### Brightness level

Adjust screen brightness manually.

### Dark mode

Empty screen space will become black in this mode, making it easier to look at your screen or read in dim light.

### Eye comfort mode

**Eye comfort mode** can effectively reduce blue light radiation and adjust the colour temperature to relieve eye fatigue. You can also create a custom schedule to turn it on.

### Reading mode

Turn on reading mode to switch the screen display to warmer colors to reduce the amount of light.

### Sleep

Set screen timeout.

### Font size

Slide to make the text on screen smaller or larger.

### Auto-rotate screen

Select whether the screen rotates automatically or not.

### Status bar

With this menu, you can view or hide the network speed, set the style of the status bar, enable notification folders, and change the battery percentage display.



## More display settings

### Screen saver

Set current screen saver as Colors, as well as when to start the screen saver.

### Full screen apps

Most applications installed on the phone will automatically adapt to the full screen display without setting them manually.

For the applications which do not automatically adapt to the full screen display, you can go to **Settings > Display > More display settings > Full screen apps** to set.

## 4.7 Sound & vibration

Use the Sound & vibration settings to configure many aspects of call ringtones, music, and other audio settings.

### Silent mode

Tap  to turn on silent mode.

### Phone ringtone & vibrate

Set your incoming call ringtone, turn on/off also vibrate for calls, or opt for the phone to vibrate only.

### Notification ringtone

Set the default sound for notifications.

### Alarm ringtone

Set your alarm ringtone.

### Do Not Disturb

If you do not want to be disturbed by your phone or information ringtones during work or rest, you can set the **Do Not Disturb** mode.

Swipe down the Status bar twice to access the Quick Settings panel and tap  to turn on Do Not Disturb.

## More sound settings

Set dial pad tones, screen locking sounds, touch sounds, vibration on touch, emergency alerts.

## 4.8 Notifications

In the **Notifications** menu, you can configure whether to block the notifications from this app, hide sensitive content, etc.

## 4.9 Button & gestures

### System navigation

Select your favourite navigation and button layout (only use for buttons navigation).

### Gestures

Set **Flip to mute** to mute the sounds and stop vibration from incoming calls or snooze the alarm.

### Power key

Turn on/off the quick short functions about the Power key, as well as the Power key menu.

## 4.10 Smart Manager

**Smart Manager** ensures your phone is operating in top form by automatically scanning and optimising data usage to preserve battery levels, manage storage and protect against security threats.

You can also do some manual settings for further optimisation.



## 4.11 Security & biometrics

### Screen lock

Select one method such as **Swipe**, **Pattern**, **PIN**, or **Password** to unlock the screen.

### Face unlock

**Face unlock** allows you to unlock your device with your facial data. Set it according to the on-screen steps.

Ensure that you are facing the phone screen when using face recognition.

**NOTE:** Another screen lock method must be enabled before configuring Face unlock.

### Smart Lock

With a Screen lock method enabled, your phone will detect when it's safe with you, such as in your pocket or at your home.

### Others

You can also set **Quick assistance**, **Device admin apps**, **Encryption & credentials** and etc.

## 4.12 Location

Allow an app to access your device's location. You can set to allow continual access, or only while the app is in use.

## 4.13 Privacy

To protect your privacy, you can set an app to be allowed or forbidden access to your location, SMS, phone, etc. Also whether or not to show passwords, choose the activities and info that you want Google to save.

## 4.14 Apps

View details about the applications installed on your phone, to manage their data usage or force them to stop.

In the **Permission manager** menu of an application, you can grant permissions for the app, such as allowing the app to access your **Camera**, **Contacts**, **Location**, etc.

## 4.15 Storage

Enter **Settings > Storage** to check the usage of storage space and free up more when necessary.

## 4.16 Accounts

Add, remove, and manage your email and other supported accounts. You can also use these settings to control the options for how all applications send, receive and synchronize data; i.e. if this is done automatically, according to a schedule for each app, or not at all.

Tap **Add account** to add an account for the selected app.

## 4.17 Digital Wellbeing & parental controls

In this menu you can find how much time you have spent on the phone and even on each app. You can customize the time limit for using the phone to ensure a healthy and balanced life.

In addition, parents are able to restrict their children's usage time to manage their browsing habits.

## 4.18 Google

Configure your Google account and service settings.

## 4.19 Accessibility

Use the Accessibility settings to configure any accessibility plug-ins you have installed on your phone.

## 4.20 System

### About phone

View basic information for your phone such as model name, CPU, camera, resolution, etc.

You can also check legal information, build number, status and other specs.

### System Update

If you want to update the system, tap **CHECK FOR UPDATES** (refer to “**5 FOTA upgrade**”).

### Languages & input

Configure language settings, the on-screen keyboard, voice input settings, pointer speed, etc.

### Date & time

Use Date & time settings to customize your preferences for how date and time are displayed.

### Backup

Turn on  to back up your phone's settings and other application data to Google servers. If you replace your phone, the settings and data you've backed up will be restored onto the new phone when you sign in with your Google account.

### Reset

Reset all network settings and app preferences, you won't lose your data with these settings.

If **Factory data reset** is selected, all data in your phone's internal storage will be erased, please back up your data before reset.

## Regulatory & safety

View product information such as **Product model, Manufacturer name, IMEI, CU reference, Bluetooth Declaration ID**, etc.

## User Experience Improvement Programme

Join the User Experience Improvement Programme so we can continue to improve our product design and overall user experience.

## 5 FOTA upgrade

Use the FOTA (Firmware Over The Air) upgrade to update your phone's software.

To access updates, from the app list, tap **Settings > System > System Update**. Turn on data connection or Wi-Fi before searching for updates.

With Wi-Fi turned on, the system is able to discover if a new firmware version is available and if so, begin to download it automatically. Once finished, a pop up dialog will give you the option of updating your phone now or later.

If **Settings > System > System Update > ⋮ > Update settings > Automatically update** is turned off, a pop up dialog will ask if you want to download a new firmware version which the phone has discovered, or if you want to ignore it.

If you only have a cellular network connection, you will only receive a notification which will appear in the Status bar.

## 6 Troubleshooting

Before contacting the service centre, here are some instructions to help you troubleshoot your device:

- For optimal operation, fully charge the battery.
- To improve the phone's performance, remove unnecessary files or apps on your phone.
- Update your phone's software via **Settings > System > System Update**.
- Reset your phone via **Settings > System > Reset > Factory data reset**. Another method is to hold down the **Power** key and the **Volume up** key at the same time when your phone is powered off. Release the power key when the device vibrates, then select **Wipe data / factory reset > Factory data reset** to reset. All your phone data will be lost permanently. It is strongly advised to fully back up your phone data before resetting.

and carry out the following checks:

### My phone can't be switched on or is frozen

- When the phone can't be switched on, charge for at least 20 minutes to ensure the minimum battery power needed. Then switch it on again.
- When the phone falls into a loop during power on animation and the user interface can't be accessed, press and hold the **Power** key to reset. This eliminates any abnormal OS booting issues caused by third party applications.
- If neither method is effective, reset the phone by pressing the **Power** key and the **Volume up** key at the same time. Release the power key when the device vibrates, then select **Wipe data / factory reset > Factory data reset** to reset.

### My phone has not responded for several minutes

- If your phone doesn't respond, turn off your phone by pressing and holding the **Power** key until it turns off and then restart it again.
- If it still doesn't work, reset the phone.

### My phone turns off by itself

- Check that your screen is locked when you are not using your phone, and make sure that the **Power** key is not accidentally pressed while the screen is unlocked.
- Check the battery charge level.

- If it still doesn't work, reset the phone or update software.

### **My phone can't charge properly**

- Make sure that you are using the TCL charger that comes with the phone.
- Make sure that your battery is not completely discharged; if the battery power has been empty for a long time, it may take around 20 minutes to display the battery charging indicator on the screen.
- Make sure that charging is carried out under normal conditions 0°C (32°F) to 40°C (104°F).
- When abroad, check that the voltage input is compatible.

### **My phone can't connect to a network or "No service" is displayed**

- Try connecting to the network by moving to another physical location.
- Verify the network coverage with your carrier.
- Check with your carrier that your SIM card is valid.
- Try connecting at a later time if the network is overloaded.

### **My phone can't connect to the internet**

- Make sure that the internet access service of your SIM card is available.
- Check your phone's internet connection settings.
- Make sure that you are in a place with network coverage.
- Try connecting at a later time or another location.

### **Invalid SIM card**

- Make sure that the SIM card has been correctly inserted.
- Make sure that the chip on your SIM card is not damaged.
- Make sure that the service of your SIM card is available.

### **My phone can't make outgoing calls**

- Make sure that you have dialled a valid number and have tapped .
- For international calls, check the country and area codes.
- Make sure that your phone is connected to a network, and the network is not overloaded or unavailable.

- Check your subscription status with your carrier (credit, SIM card valid, etc.).
- Make sure that you have not barred outgoing calls.
- Make sure that your phone is not in Airplane mode.

### **My phone can't receive incoming calls**

- Make sure that your phone is switched on and connected to a network (check for overloaded or unavailable network).
- Check your subscription status with your carrier (credit, SIM card valid, etc.).
- Make sure that you have not forwarded incoming calls.
- Make sure that you have not barred certain calls.
- Make sure that your phone is not in Airplane mode.

### **The caller's name/number doesn't appear when a call is received**

- Check that you have subscribed to this service with your carrier.
- Your caller may have concealed his name or number.

### **I can't find my contacts**

- Make sure that your SIM card is not broken.
- Make sure that your SIM card is inserted properly.

### **The sound quality of the calls is poor**

- Adjust the volume during a call by pressing the **Volume** key.
- Check the network strength. Move to a location with stronger signal strength.
- Make sure that the receiver, connector and speaker on your phone are clean.

### **I can't use the features described in the manual**

- Check with your carrier to make sure that your subscription includes this service.
- Make sure that this feature doesn't require a TCL accessory.

### **When I select a number from my contacts, the number can't be dialled**

- Make sure that you have correctly recorded the number in your contacts.
- Make sure that you have selected the country code when calling an international number.

### **I can't add a contact**

- Make sure that your SIM card contacts are not full; delete some contacts or save the contacts to the phone.

### **My callers can't leave messages on my voicemail**

- Contact your network carrier to check service availability.

### **I can't access my voicemail**

- Make sure that your carrier's voicemail number is correctly entered in "Voicemail number".
- Try later if the network is busy.

### **I can't send and receive MMS**

- Check your phone storage as it might be full.
- Contact your network carrier to check service availability and MMS parameters.
- Verify the server centre number or your MMS profile with your carrier.
- The server centre may be swamped. Try again later.

### **SIM card PIN locked**

- Contact your network carrier to obtain the PUK (Personal Unblocking Key) code.

### **I can't connect my phone to my computer**

- Check to make sure the USB port is not broken. If it's not working, try another USB port on your computer.
- Make sure USB drivers are properly installed.
- If you are using a Windows computer, make sure it supports MTP mode. If you are using a Mac, make sure to install Android File Transfer from [www.android.com/filetransfer/](http://www.android.com/filetransfer/).

### **I can't download new files**

- Make sure that there is sufficient phone storage space for your download.
- Select the microSD™ card as the location to store downloaded files.
- Check your subscription status with your carrier.

### **The phone can't be detected by others via Bluetooth**

- Make sure that Bluetooth is turned on and your phone is visible to other users.
- Make sure that the two phones are within Bluetooth's detection range.

### **The battery drains too fast**

- Make sure that you follow the complete charge time (minimum 150 minutes).
- After a partial charge, the battery level indicator may not be exact. Wait for at least 20 minutes after removing the charger to obtain an exact indication.
- Adjust the brightness of screen as appropriate.
- Extend the email auto-check interval for as long as possible.
- Update news and weather information on manual demand, or increase their auto-check interval.
- Exit background-running applications if they are not being used for extended periods of time.
- Turn off Bluetooth, Wi-Fi, or GPS when not in use.

### **The phone becomes warm following prolonged calls, game playing, internet surfing or running other complex applications**

- This heating is a normal consequence of the CPU handling excessive data. Ending the above actions will make your phone return to normal temperature.

### **After a factory data reset is performed, I can't use my phone without entering Google account credentials**

- After a reset is performed, you must enter the original Google account credentials that were used on this phone.
- If you don't remember your Google account credentials, complete Google account recovery procedures.
- If you still cannot access your phone, apply to the authorized repair centre, but remember that it will not be regarded as a warranty case.

### **I forgot some passwords/codes/keys on my phone**

- Perform a factory data reset.
- If you still cannot access your phone, apply to the authorized repair centre, but remember that it will not be regarded as a warranty case.

## How to back up my device data

- Go to **Settings > System > Backup** (refer to “4.21 System > Backup”)
- You can also back up your data to another phone via the **Switch Phone** app. Swipe up from the home screen to find the search bar and enter **Switch Phone**, transfer data by following the instructions.

## 7 Specifications

### Platform:

- MTK6761V/WB

### OS:

- Android 11 (Go Edition)

### Memory:

- 32GB ROM + 2GB RAM

### Dimensions (LxWxT):

- 146.66 x 71.9 x 9.95 mm

### Weight:

- 172g

### Display:

- 5.5" with 720 x 1440 HD+ (in-cell)

### Network<sup>(1)</sup>:

- GSM B2/3/5/8
- UMTS B1/2/4/5/8
- LTE: B2/4/5/7/12/13/17/66/71

### GPS:

- GPS (with A-GPS), Glonass+Beidou+Galileo

### Connectivity:

- Bluetooth 5.0
- Wi-Fi 802.11b/g/n
- 3.5 mm audio jack
- Micro-USB

### Camera:

- Rear Camera: 8MAF
- Front camera: 5M

<sup>(1)</sup> Network availability is dependant on your cellular carrier.



### Audio & Video supported formats:

- AAC, AMR, AWB, MP3, AAC+, Vorbis, FLAC, eAAC+, PCM playback
- 1080P@30fps, H.263, H.264 AVC, H.265, HEVC ,VP8, VP9, MPEG-4

### Battery <sup>(1)</sup>:

- Capacity: 3000 mAh

### Expansion Slot:

- microSD™ memory card

(Availability of microSD™ card up to 128GB)

### Sensors:

- G-sensor

**Note:** Specifications are subject to change without prior notice.

## 8 Accessories

### Standard accessories

- Charger
- Micro-USB Cable
- Quick Start Guide
- Product safety and warranty information



- Accessories depend on countries.
- Only use the TCL batteries, chargers, and accessories included along with your device.

<sup>(1)</sup> The original battery has undergone rigorous safety inspections to meet qualification standards, the use of non-original batteries may be dangerous.

## 9 Licenses



microSD logo is a trademark of SD-3C, LLC.

---



The Bluetooth® word mark and logos are owned by the Bluetooth SIG, Inc. and any use of such marks by TCL Communication Ltd. and its affiliates is under license. Other trademarks and trade names are those of their respective owners.

**TCL 5131E** Bluetooth Declaration ID D059652

---



The Wi-Fi CERTIFIED Logo is a certification mark of the Wi-Fi Alliance.

---



Google, the Google logo, Android, the Android logo, Google Search™, Google Maps™, Gmail™, YouTube, Google Play Store, Google Latitude™, and Hangouts™ are trademarks of Google Inc.

---

The Android robot is reproduced or modified from work created and shared by Google and used according to terms described in the Creative Commons 3.0 Attribution License (the text will show when you tap **Google legal** in **Settings > About phone > Legal information**) <sup>(1)</sup>.

You have purchased a product which uses the open source (<http://opensource.org/>) programs mtd, msdosfs, netfilter/iptables and initrd in object code and other open source programs licensed under the GNU General Public Licence and Apache Licence.

You may download the source codes from <https://sourceforge.net/projects/tcl-mobile/files/>. The provision of the source code is free of charge from the internet.

<sup>(1)</sup> May not be available in all countries.

## 10 Disclaimer

There may be certain differences between the user manual description and the phone's operation, depending on the software release of your phone or specific carrier services.

TCL Communication Ltd. shall not be held legally responsible for such differences, if any, nor for their potential consequences, which responsibility shall be borne by the carrier exclusively.

# DISPLAY GREATNESS

For more information on how to use the phone, please go to [tcl.com](http://tcl.com) and download the complete user manual. The website will also provide you with answers to frequently asked questions.